



SOLOMON ISLANDS COCOA BOOK

***Solomon Islands Cocoa Livelihoods
Improvement Project (CLIP)***



Australian Government

Aid Program

ABOUT THIS BOOK

This book was written and published by staff of the Solomon Islands Cocoa Livelihoods Improvement Project (CLIP) in 2010. CLIP is an **Australian Government Aid Program** funded initiative to assist smallholder cocoa farmers in Solomon Islands.

Riaz Meninga has drawn most of the pictures used. Layout, Design & Picture colouring by Koko Siga, Fiji

ACKNOWLEDGEMENTS

Acknowledgment is given to previous researchers and staff from Lowlands Agricultural Experimental Station, Papua New Guinea and Cocoa Coconut Institute, Tavilo, Papua New Guinea and staff of the previous Samoa Cocoa Project. They have provided information and sketches used from books including *Torubat Wokim Bisnis Long Kakao*, (Trevor Clarke 1981) *Joseph Grows Cocoa*, and *The Cocoa Book*, Western Samoa. Drawings from Cocoa Board of PNG Publications on Cut tested beans, Black Pod and Vascular Streak Dieback (VSD) drawn by Celia Bridle have also been used.

The Research Bulletin No. 2 revised, entitled *A Guide to Growing Cocoa in Solomon Islands*, written by K. Trewran, based on previous edition by P.R. Linton has also been used a key reference.

Valuable inputs from staff of the Solomon Islands Ministry of Agriculture and Livestock, (MAL) and Commodity Export Marketing Authority (CEMA) have also been incorporated.

CONTENTS

PAGE

<i>INTRODUCTION</i>	<i>5</i>
<i>SOIL</i>	<i>6</i>
<i>SHADE</i>	<i>10</i>
<i>COVER CROPS</i>	<i>16</i>
<i>PLANTING SEEDS</i>	<i>23</i>
<i>PLANTING OUT SEEDLINGS</i>	<i>28</i>
<i>MAINTENANCE OF YOUNG COCOA</i>	<i>32</i>
<i>COCOA REHABILITATION</i>	<i>52</i>
<i>HARVESTING AND PROCESSING</i>	<i>58</i>
<i>PEST AND DISEASE CONTROL</i>	<i>77</i>
<i>CHEMICALS</i>	<i>80</i>
<i>COMMON COCOA INSECTS</i>	<i>81</i>
<i>DISEASES OF COCOA</i>	<i>100</i>
<i>MEANING OF WORDS USED</i>	<i>109</i>
<i>KEEPING RECORDS</i>	<i>116</i>



Cocoa growers can receive a good income to support their families

INTRODUCTION

Cocoa has been grown in Solomon Islands since plots were established in Aimela, Malaita in 1958, and the first cocoa production of three tonnes was sold in 1960. Production didn't start picking up until the late 1970's. Amelonado cocoa was introduced among other varieties, and was found to be the most suitable variety for Solomon Islands conditions.

Plantations and many small holder farmers planted cocoa from the 1970's on, and have since received a steady income from this crop.

After logging and oil palm, cocoa is the third highest revenue earner for Solomon Islands, but is especially important for smallholders because it spreads wealth further than other options and is less damaging to the environment.

COCOA AS A BUSINESS

Cocoa is subject to supply and demand on the world market, like other commodities, which causes the price to go up and down. However, over the years cocoa prices have proved to be relatively stable, with fewer price fluctuations than other major commodities.

Cocoa can be a rewarding crop for smallholder families to grow if the right management practices are applied.

Much of the cocoa in Solomon Islands is not properly managed and yields are low. The crops true potential is not fully realized.

Read this book and learn how to improve the productivity of smallholder cocoa in Solomon Islands.

CLIMATIC REQUIREMENTS

Cocoa production is most suited to the following climatic conditions

Rainfall	<ul style="list-style-type: none">• 1,500 mm to 4,000 mm per annum• The climate is too dry if rainfall is less than 100 mm average per month for three or more consecutive months.
Temperature	Minimum 21 degrees Celsius to a Maximum of 31 degrees Celsius
Sunshine	4.5 to 6.5 hours of direct sunlight per day
Altitude	Up to 600 metres above sea level

SOILS

The best soils for cocoa are;

- at least one metre deep, free of big stones
- well drained – no excess water
- high organic content black forest soils best
- PH level (acidity /alkalinity) of 6.5 to 7.5

Unsuitable soils for cocoa are:

- Shallow
- Stony
- Waterlogged

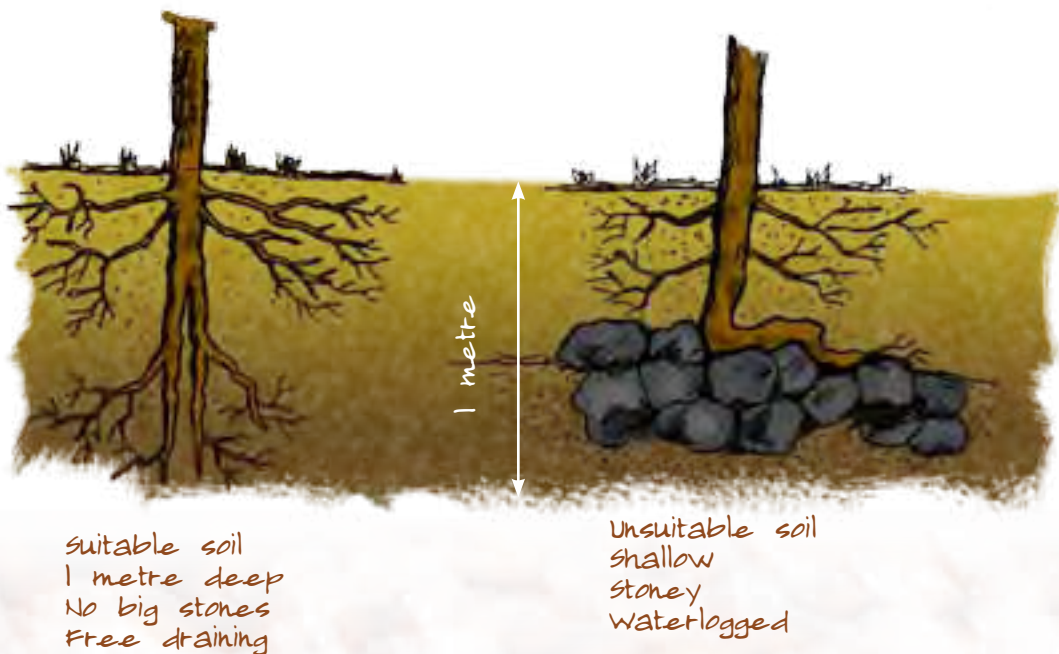

SELECTING A SUITABLE SITE

It is not a good idea to clear new sites for cocoa if your old cocoa trees are not producing and just need to be rehabilitated. It is better to rehabilitate cocoa rather than clear bush unnecessarily. Always make sure you leave enough land for food gardens and houses, and bush for firewood and building materials

With new cocoa, only plant what you and your family can manage. An average family of six can comfortably manage 500 -1000 trees.

- Secondary regrowth bush is preferable to primary forest sites.
- Food gardens can be used, with bananas providing temporary shade until cocoa trees are established.
- The slope of the area should not be more than 30 degrees.
- The site should not be too close to the sea, as salt will damage cocoa leaves.

Bush should be cleared before planting shade trees and cocoa seedlings .The problem with using bush as shade is that it is difficult to remove or thin- out later when the young cocoa trees need more sunlight to produce pods.



LINING OR MARKING OUT

Marking out a new cocoa farm should be done using a rope with 3.5 metre intervals or 4 metres if a wider spacing is preferred. 3.5 metre intervals can be painted along the rope to give a 3.5 metre square spacing suitable for Amelonado type cocoa plants. Experience shows that 3 metre spacing is too close, and under village or smallholder management can quickly become overgrown.

Gliricidia sticks about 1.5 metres long, and sharpened at one end are good for marking out because when the marking sticks grow they provide shade. Cocoa seedlings should be planted half-way between gliricidia sticks.

Marking out lines should follow an east-west direction for maximum sunlight to reach cocoa trees.

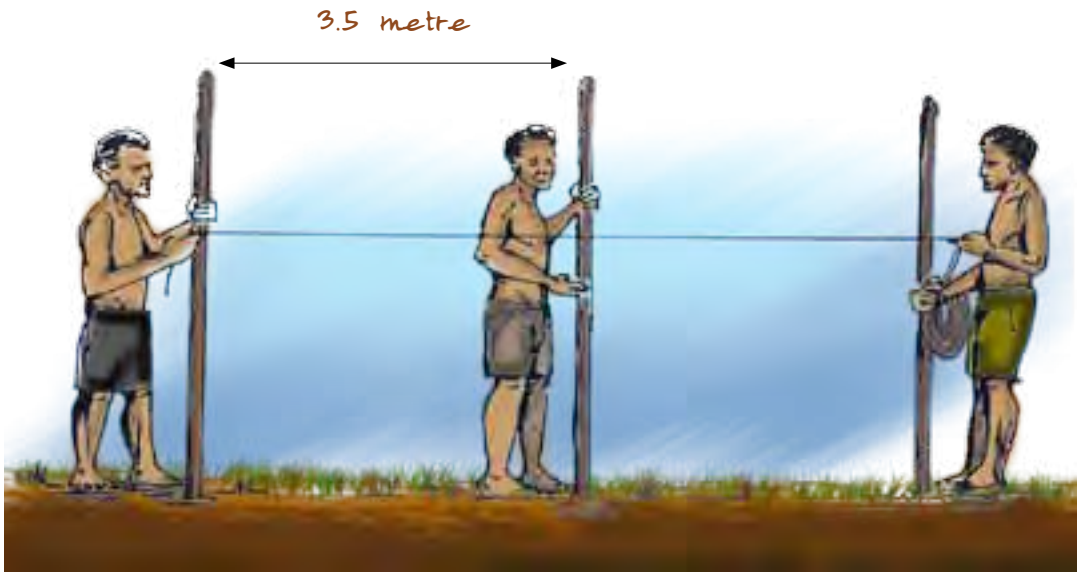

Marking out with a string line marked at 3.5 metre intervals

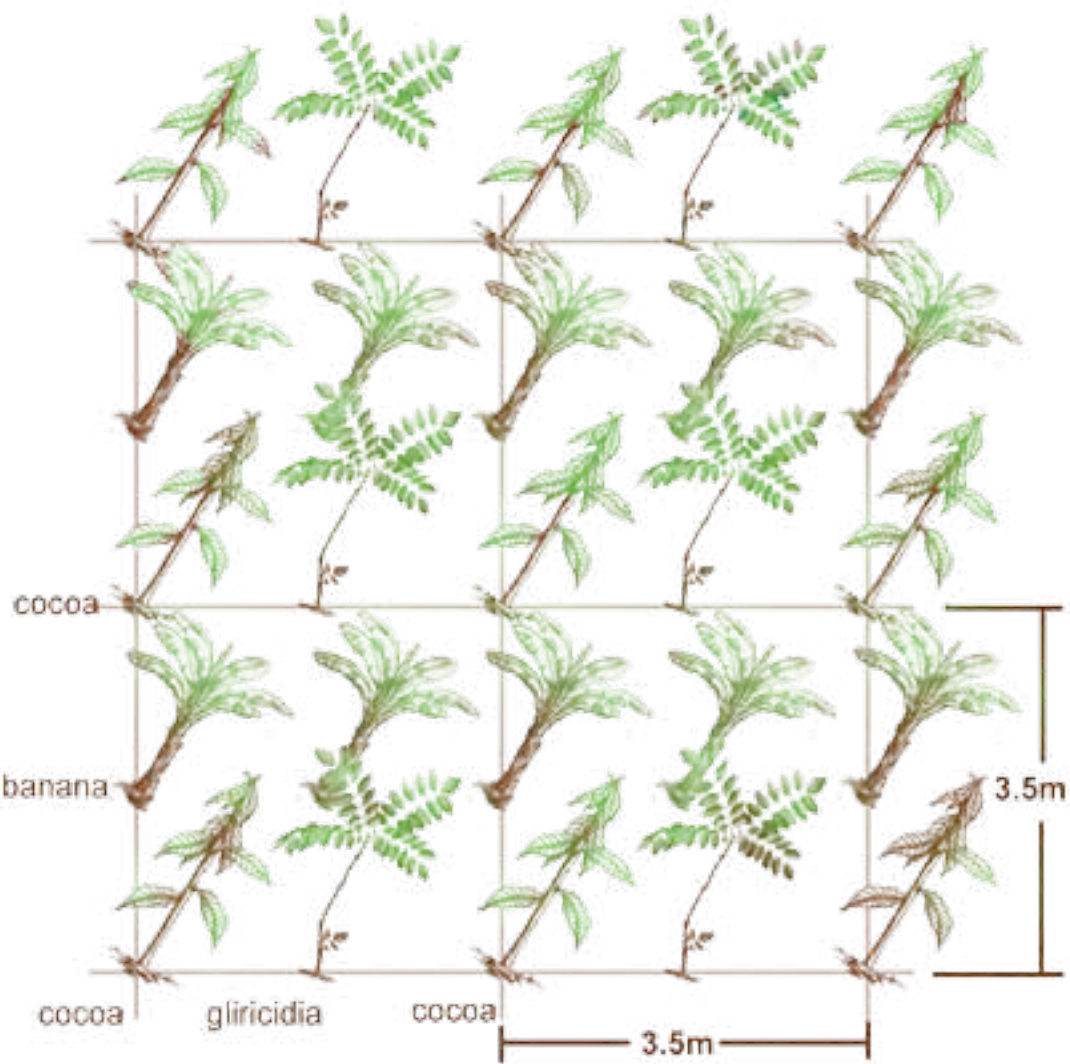

SHADE

Planting shade trees in combination with food crops in new cocoa farms provides the best use of labour and land. Bananas can be used as temporary shade, particularly varieties that don't have many suckers because they are easier to remove when the cocoa trees mature.

PERMANENT SHADE

Coconuts

Coconuts are a good permanent shade crop if planted wide enough apart to allow enough sunlight through to the mature cocoa. They provide a second cash crop and there are generally less insect problems in cocoa under coconuts because of better light and air ventilation.

Coconuts should be planted 2-3 years before cocoa. Coconuts should be widely spaced at about 10.5 metres apart. (90 trees per hectare). Closer spaced coconuts will not be suitable for interplanting cocoa because there will be too much shade.

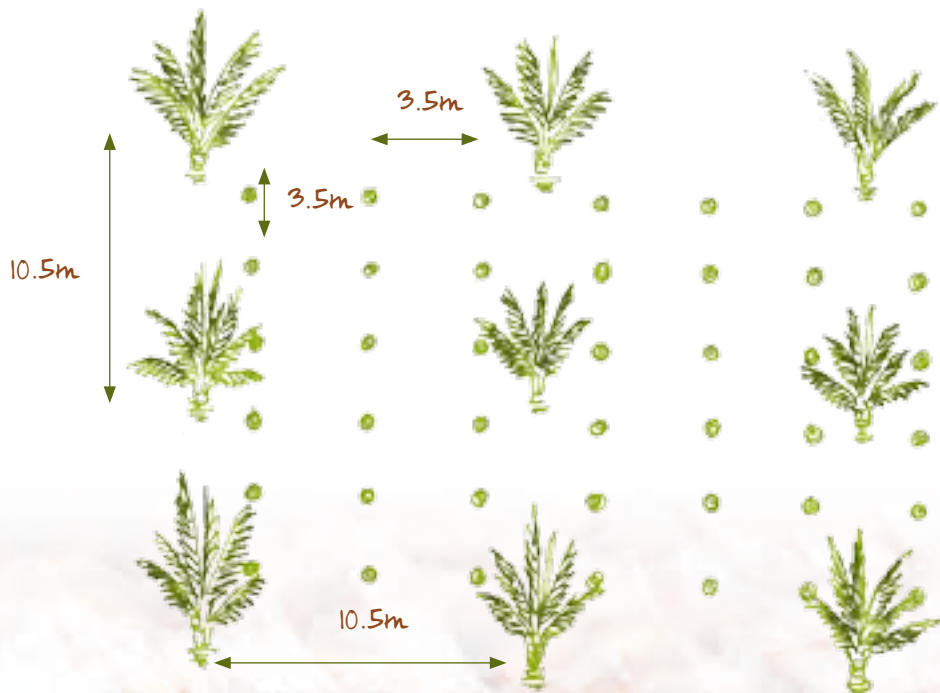



Marking out under coconuts already established

When planting cocoa under mature coconuts that are close together, assess the sunlight and remove some coconut trees to allow sunlight for cocoa.

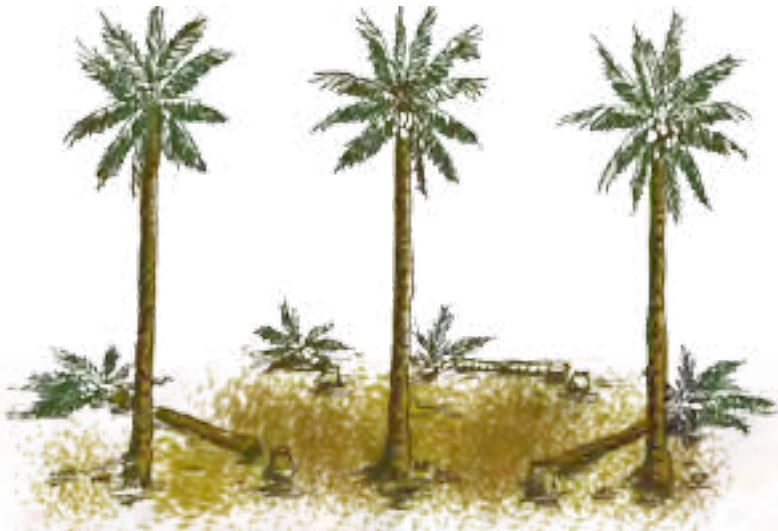

Thinning out coconuts to allow more sunlight for cocoa



Allow more sunlight in by removing some coconuts

Gliricidia

Gliricidia is easy to establish and is a fast growing shade tree. It is also a legume, returning nitrogen to the soil, will attract crazy ants which help control cocoa pests and is a good source of firewood.

Gliricidia can be hard to manage if the trees get too big leading to overshadowing of cocoa trees.

Plant gliricidia 6- 9 months before cocoa seedlings. Planting sticks should be 1.5 metres long and sharpened at one end. Use a crowbar or hardwood stick to dig a planting hole that is slightly bigger than the girth of the gliricidia stick, and 200 mm or more deep.



Lining and marking out at 3.5 metres using gliricidia sticks

Betel nut

Betel nut is a good crop shade for cocoa. They should be planted between every second cocoa tree. This is about 400 betel nut trees per hectare, which should allow enough sunlight through for the cocoa to produce well. Unlike coconut, betel nut palms can force their way through an established cocoa canopy.

Betel nut provides a good second income source.

Bush Shade

Cocoa should not be planted under heavy regrowth or primary forest. Not enough sunlight will be available for the cocoa trees to produce properly when they are mature. Some bush trees are also hosts to cocoa pests and diseases.

Fruit and nut trees (such as ngali) are best planted around the boundary of the cocoa farm. This way they act as a wind break and also provide some shade to the cocoa trees and provide food and income.

Some fruit trees such as sour sops, lemons, cut nuts and ngali host green tree ants (Ekofola) which control pests of cocoa.

Agro forestry

Planting cocoa under trees such as teak is similar to using bush shade. The dense shade from the teak means that there is not enough sunlight for the cocoa to produce well and this is not recommended.

COVER CROPS

Cover crops are crops planted to cover the ground, fertilize the soil and prevent weed competition.

Legumes such as peanuts which provide a second income, or other legumes which grow in shady conditions are best.

TEMPORARY SHADE

Bananas

Bananas are a good shade crop that also provide an important source of food, but need to be removed 4 to 6 months after cocoa is planted. Bananas that have fewer suckers are easier to remove and should be planted between every second cocoa position, alternating with gliricidia.



Bananas used for temporary shade

Pigeon pea

Pigeon pea seed can be planted between cocoa seedling rows. Pigeon pea improves the soil as a legume and a mulch. Pigeon pea seeds are edible and are recommended for both livestock and people.

A couple of pigeon pea seeds should be planted in holes spaced 1 metre away from cocoa seedlings. Pigeon pea will die out after a year or so.



Planting pigeon pea as temporary shade

NURSERIES AND PLANTING OUT

A nursery is used to produce good quality cocoa seedlings that can be quickly transported to the cocoa farm and planted out after spacing, lining and shade establishment have been done.

Cocoa seedling nurseries should be located near the proposed cocoa farm, should have access to water, and be secure from pigs.

DIRECT PLANTING

Direct planting is planting the seeds straight in to the field.

If a nursery is not managed properly and the cocoa seedlings are spindly and weak from over shading, direct planting is recommended. If only a few cocoa seedlings are required to fill in gaps in the farm, it is easier to direct plant using good Amelonado seeds.

When direct planting seeds, loosen the soil before planting. Plant 3 seeds. After two or three months select the strongest seedling and remove the other two.



Direct planting

NURSERY PREPARATION

Seedlings are reared in a nursery and then transported to the planting site.

Seedlings in planting bags will normally stay in the nursery 3 to 4 months. Black polythene planting bags that measure 25 centimetres long by 12.5 centimetres wide are recommended. The bags have holes which allow water drainage.

If a plastic rice or sugar bag is used, it should be 25cm long and make holes in it for water drainage. Bags must be long enough to enable good tap root development.



Black polythene planting bag
25 cm x 12.5 cm

Fill bags with good forest top soil



10 mm _____



The planting bag should be filled up with good forest top soil, not sub-soil or silt.

Avoid using soil from old cocoa farm sites because pests and diseases may be in the soil.

The planting bag should be filled with soil up to 1 cm from the top of the bag. This is so the top of the bag doesn't fold back inwards and prevent water and air getting in.

The bags should be lined up in rows no more than three metres wide, with a support wire or bamboo used to keep the bags upright.



Lining up the bags in the nursery

Young cocoa seedlings need a certain amount of shade to grow well. Too much shade will cause seedling blight and weak seedlings. Not enough shade will cause the seedlings to be yellow and unhealthy.

Young cocoa seedlings need about 50 % shade cover to grow well.

A bush timber frame should be constructed capable of supporting 50% shade cloth or palm leaves. Palm leaves should allow 50% of sunlight through to the seedlings. They can be thinned out to allow 70% sunlight through when seedlings are nearly big enough to plant out.

Shade cover is also needed to prevent damage to seedlings from heavy rain, and rain drops splashing diseased soil onto seedling leaves.



Reducing the level of nursery shade

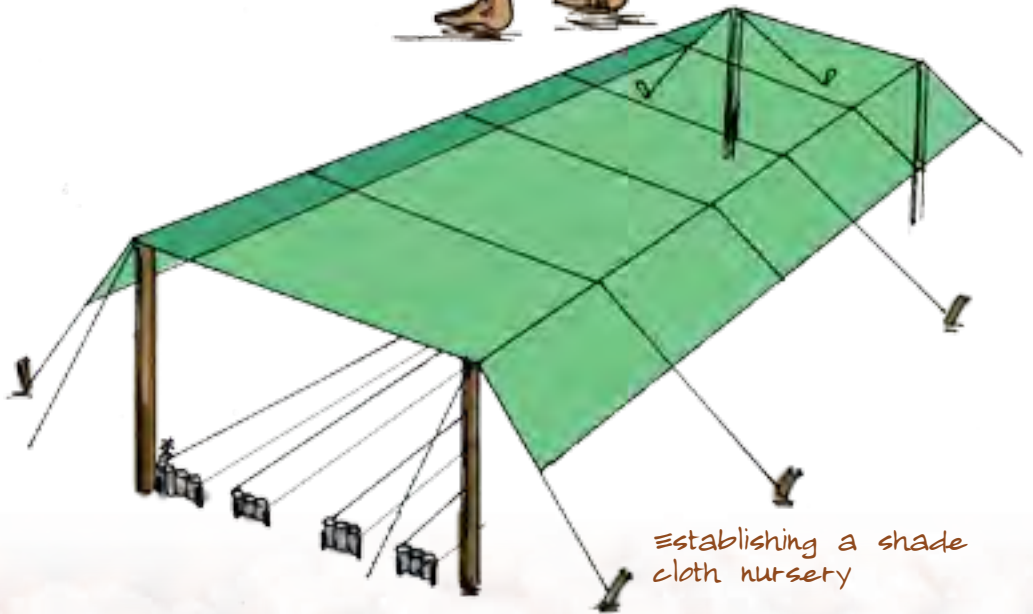

Establishing a shade cloth nursery

Timber posts with wire supports can be used to make larger nurseries. 50% shade cloth can be used to cover the frame.

PLANTING SEEDS

A fungal disease that is common in nurseries (especially in wet humid conditions) is called seedling blight. The leaves of seedlings turn brown and the seedling dies. The seedlings twist into a hook shape.

To prevent seedling blight, soak 1000 cocoa seeds in a Ridomil (Metalaxyl) solution of 30 grams powder to 3 litres of water in a bucket for 20 minutes before planting. 30 grams of powder is about 3 match boxes full.

Always use gloves when handling Ridomil because it is poisonous and can make you sick.

*soak seeds in a bucket with
Ridomil to prevent seedling blight
in the nursery*



seedling blight affecting seedlings

PLANTING SEEDS

The recommended way to plant cocoa seeds is to lay them flat on the soil inside the poly bag, then carefully push them about 25 mm or 1 inch into the soil. If you plant them up side down, the root will be twisted and the seedling ruined.

Seed planted flat safest planting method



If planted upside down, twisted tap root



Planting seeds in polybags 2.5 cm deep, and planted flat



Planting seeds in polybags 2.5 cm deep, and planted flat

MAINTENANCE OF SEEDLINGS

If the cocoa seedlings get seedling blight it usually means they have too much shade. Check shade levels and reduce the shade cover. Remove diseased seedlings immediately and discard them away from the nursery.

Ridomil (Metalaxyl) can be sprayed on to seedlings every month to prevent seedling blight.

The mixture for spraying is 20 ml (two match boxes full of Ridomil powder) to 10 litres water in a knap sack.

If leaf eating insects are a problem, a solution of common insecticide, such as "karate", can be sprayed to kill them.

Seedlings in the nursery require regular watering. If there is no rain, daily watering by an irrigation system or watering can is needed.

Seedlings must be regularly weeded. Young weeds need to be pulled out before they get too big and compete with the cocoa for moisture and nutrients.



Water seedlings regularly during dry periods

HARDENING OFF

Seedlings are exposed to higher levels of sunlight to harden them before planting in the cocoa farm.

If seedlings are not hardened off, they may get a shock from direct sunlight when planted out and die or be severely set back. A few weeks before you intend to plant the cocoa seedlings, reduce the shade level to 20-30%. This may mean taking the seedlings out of the nursery to a more sunny location, or reducing the level of shade by removing palm fronds.

REMOVE WEAK SEEDLINGS

Some seedlings (up to 10-15%) are not strong and should be thrown away. If they are weak in the nursery they will be weak in the field, and should be discarded.

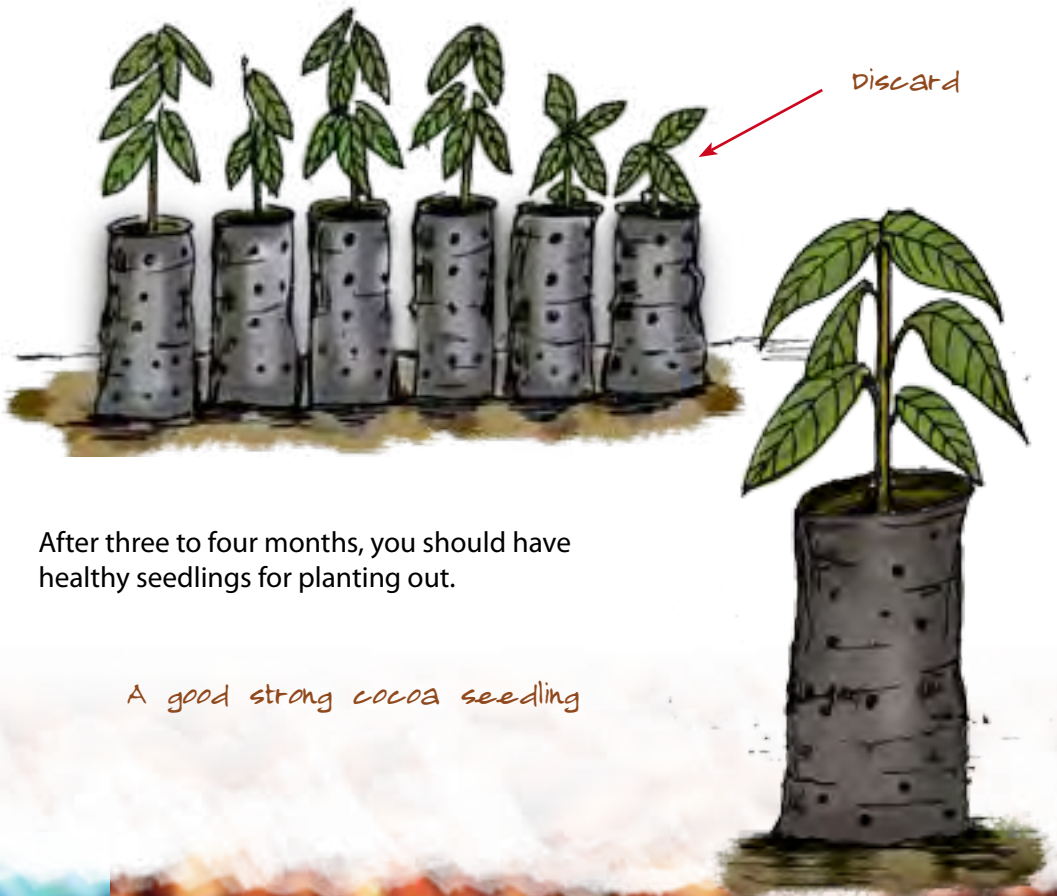

After three to four months, you should have healthy seedlings for planting out.

A good strong cocoa seedling

BUDGRAFTING

Budgrafting is a method of making sure that the best cocoa trees are used for planting material.

Scientists select the best trees for producing many pods with good bean size, good flavor, and high fat content, thin shell, and pest and disease resistance.

If you plant seeds from these trees, they may not always have the same good qualities and they may grow differently from the mother tree.

If you produce a new tree vegetatively by bud grafting, there is more chance of the new plant having the same good qualities as the mother tree.

To budgraft, take young branches, called bud wood, off good mother trees. Bud wood should be green turning brown.

Buds are cut off the bud wood and grafted on to another cocoa seedling (root stock), and the growth from the bud develops into a good cocoa tree like the mother.

Remove leaves at tip.
Colour light brown turning green.





1. cut bark flap



2. Remove bud from budstick



3. Insert bud



4. Fasten budding tape



5. Remove tape

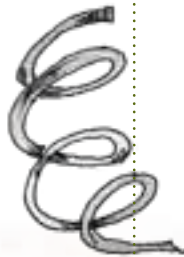

6. New Growth



7. cut off root stock when new growth established



8. New budgrafted plant

Juvenile Budgrafting

Juvenile budgrafting uses very young seedlings, only a few weeks old, to graft on to. Soft young bud wood should be collected from best mother trees. This method is becoming popular because the plant needs to spend less time (just 4 months) in the nursery.

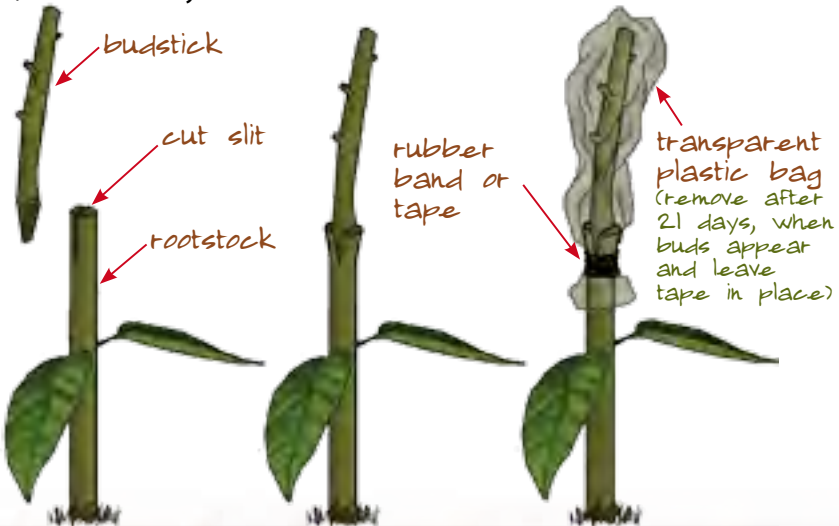

Top Grafting

Another method that can be used is top grafting, where budwood from a good mother tree is grafted onto a chupon of a poorer quality tree. The resulting growth should come up as a good quality tree, and the rest of the old tree can be sawn off leaving the good tree in its place.

PLANTING OUT SEEDLINGS

Check the following before planting out.

1. The seedling has developed properly and is 3 to 4 months old. Ensure that the seedling is not under or over-grown. An overgrown seedling is one with a large bent tap root growing through the bottom of the planting bag. It may die from shock if transplanted.
2. There is adequate shade in the farm to protect the young seedling after planting out.
3. There has been good recent rainfall and there is good soil moisture present. A cooler period is best.
4. The seedling is in good condition and free from pest and disease.
5. The seedlings should be placed in a shady, sheltered area while they are waiting to be planted.
6. Water the seedlings before planting out and plant within a few hours of watering. Water again after planting.
7. If seedlings are to be transported by vehicle, protect them from wind damage.

PLANTING

Dig a hole

- The hole should be deeper than the depth of the polybag and twice as wide. For 25 cm length polybag, this means that the hole should be 30 cm deep by 25 cm wide.

Prepare a hole for planting a cocoa seedling

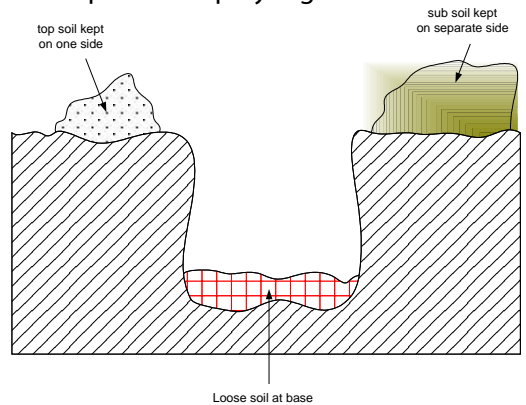

- Extra care must be taken to ensure that the top soil is kept on one side of the hole, while the sub soil is kept on the other side. Use the top soil below and around the seedling and the sub soil to compress around the top.
- The soil at the base of the hole should be loosened up using a spade, so the seedling roots can easily grow down.
- Then, using a sharp knife, slice off the bottom 2 - 3cm of the polybag, making sure that the bottom curved portion of the taproot is also cut off.
- Carefully place the seedling in hole. Make sure that the top of the polybag is level with the surface of the soil.
- Fill in some of the top soil around the bag.
- Pull the bag up over the seedling
- Compress the top soil around the seedling and the sub soil at the top.
- Collect all the used polybags and bury them.



Planting out seedlings.. cut bottom 2-3 cm off the polybag to prevent a bent tap root



Pull the polybag up over the seedling.

Fill in the rest of the hole using the top soil. Compress the remaining soil around the seedling. The seedling should be at ground level or slightly above to prevent water logging.

- Use leaves or coconut husks as mulch placed in a ring around the seedling to keep the soil cool.



Ensure the soil is higher than ground level to avoid water logging

MAINTENANCE OF YOUNG COCOA

RING WEEDING

You need to weed regularly in a ring around the base of young seedlings. The ring should be the same diameter as the height of the seedling, or 60 to 100 cms (1 metre).

This should be done every 6 to 12 weeks, depending on the weather and weed growth.

Weeds take water and nutrients away from the cocoa seedling.

Rotting weeds (without seed heads) and leaves can be put around the seedlings as a mulch to prevent moisture loss and prevent further weed growth.

Regularly weed around seedlings to prevent competition for nutrients.



REMOVE TEMPORARY SHADE

Temporary shade, such as bananas and other food crops, need to be completely removed as cocoa seedlings grow bigger. Do this in a wet period 9 to 12 months after planting out cocoa seedlings.

INFILLING

It is important to always have seedlings ready in reserve to replant the gaps caused by seedlings that die from planting shock or insect attack. Planting shock happens when the tap root is damaged when the seedling is planted out or when the seedling receives too much direct sunlight with insufficient shade.

Direct planting can also be used to fill gaps.



Infilling gaps caused by seedlings that die or are weak from insect attack.

PRUNE TO ONE MAIN STEM

If young seedlings are tip damaged they will put up two or more stems. The growing point of the stem is called the terminal bud. Remove any secondary stems so only one strong stem is left.

Terminal bud



Prune seedlings to one stem

SLASHING

To allow easy access and prevent competition from weeds, you need to regularly slash between the rows of cocoa trees. As the young cocoa trees get bigger and before they form a canopy, continue to slash and ring weed.



slash between
rows of cocoa



Ring weed as
seedlings grow
bigger

THINNING OUT SHADE

Start thinning out gliricidia shade when the cocoa seedlings are 6 to 9 months old.

3 to 4 year old cocoa requires only one shade tree to 11 cocoa trees, or about

90 shade trees per hectare.

Gliricidia trees are hard to kill. Strip the bark from knee height down to ground level to kill them.

Killing shade trees by stripping the bark down to ground level



shade thinned out

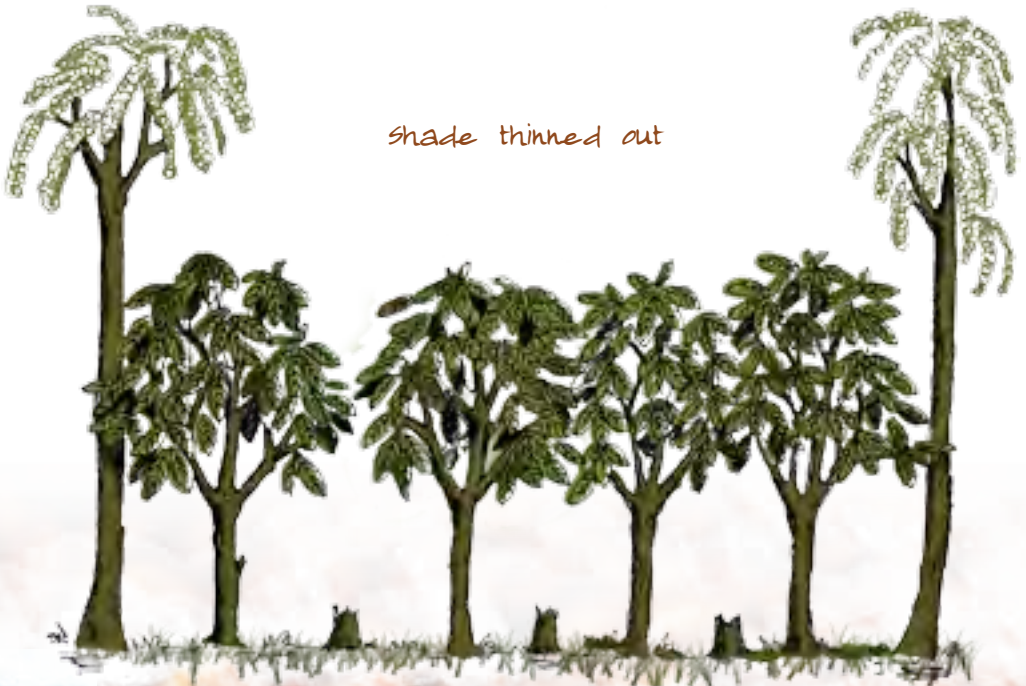

TYPES OF GROWTH

Cocoa seedlings grow with a terminal bud at the top of a single stem. After 9 or 12 months the terminal bud divides and sends out 4-6 branches called fan branches.

The point where the tree divides into branches is called the jorquette. It is called ramification when the terminal bud divides or ramifies.

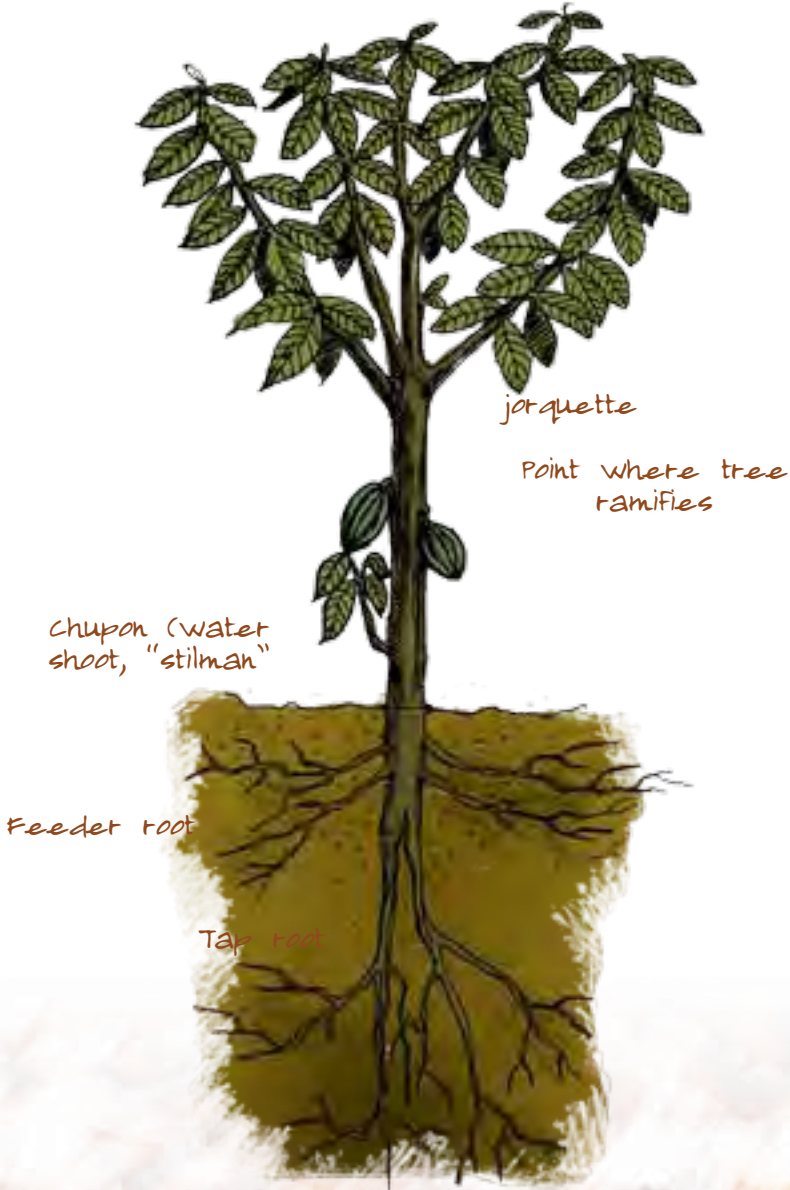

The fan branches are the fruit producing branches. The chupons (stillman) grow for height so need to be controlled.



Fan branch

Leaves on either side of branch
Fan branches grow laterally



chupon

Leaves in a spiral around the branch
chupons grow vertically

If chupons are left to grow they will produce a second or third storey of the canopy higher up. This causes over shading of lower pod producing area. The high canopy can be a source of black pod infection. To keep the tree manageable, prune off chupons regularly every month.

Chupon produces a second storey if not removed →



Second storey produced by a chupon. Tree becomes unmanageable.

FLOWER CUSHIONS

When cocoa trees grow flowers they are produced on flower cushions. These are points on the main trunk and branches where lots of flowers are produced, but only some (less than 5 %) become cocoa pods.

Young pods are known as cherelles.

Flower cushion

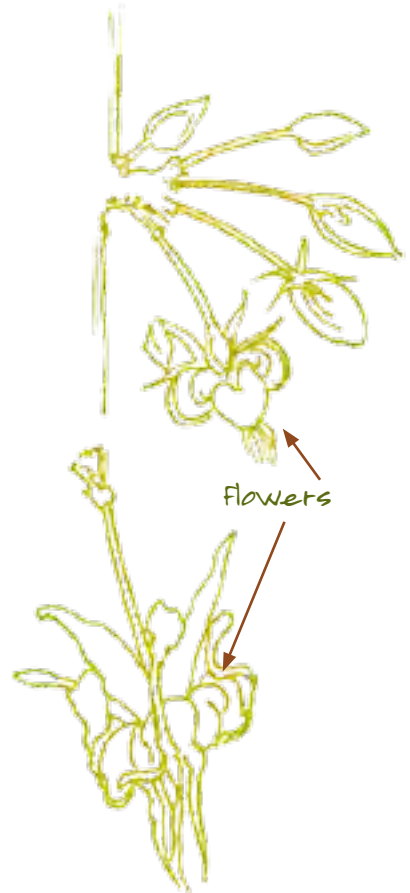
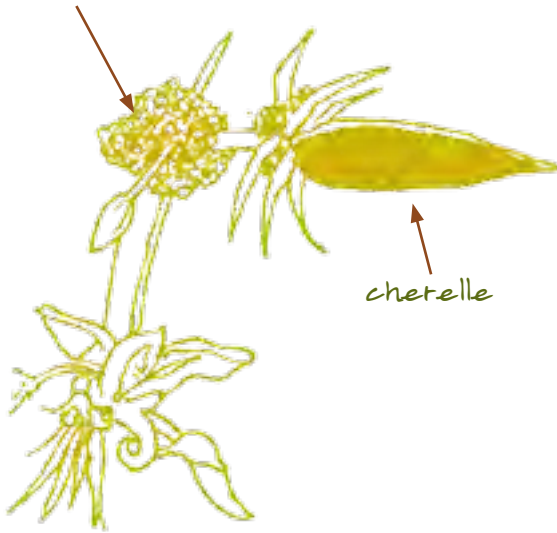

COCOA POD

It takes 6 months for development of a cocoa pod from a flower. It is important that the pod is ripe at harvest so there is enough sugar in the beans and mucilage for a good ferment.

The parts of a cocoa pod and beans are shown below.

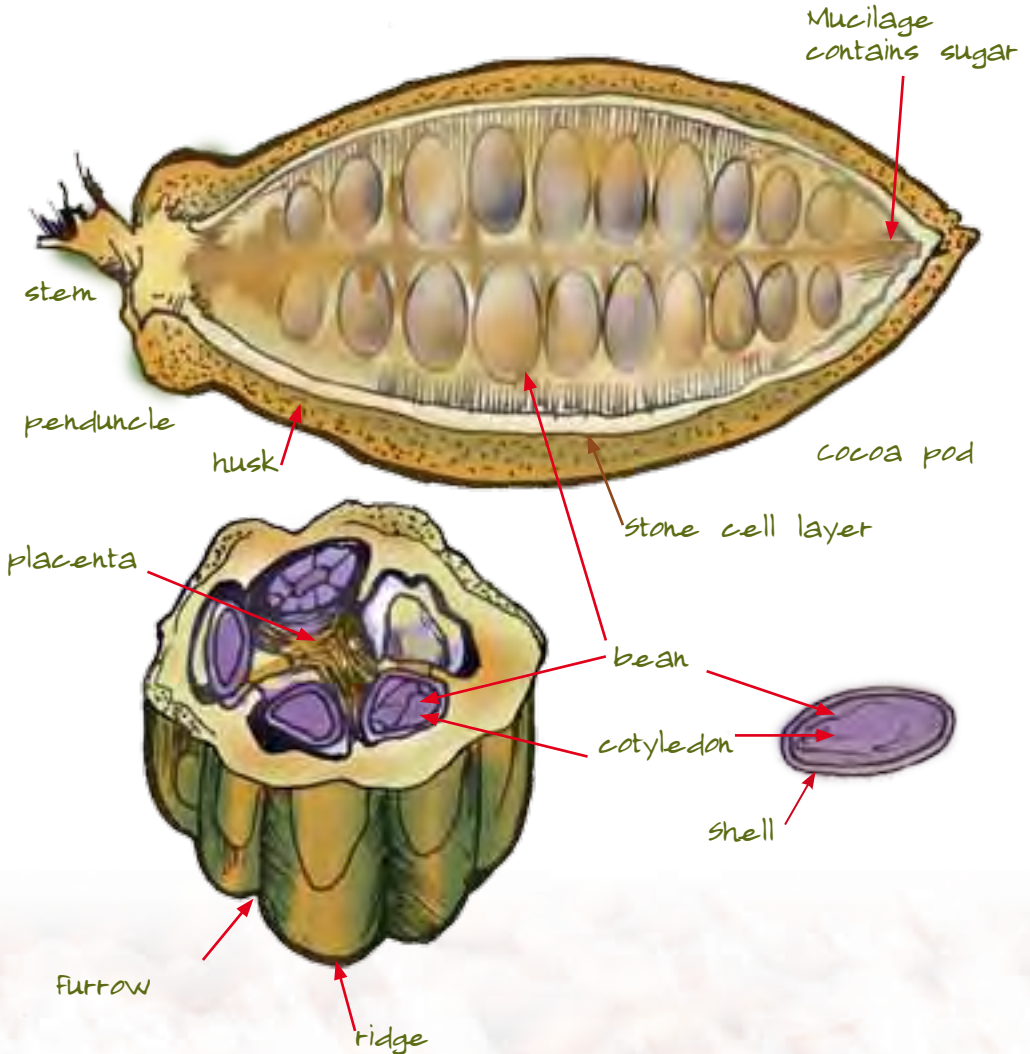

PRUNING COCOA

Things to do before pruning

1. Slashing and weed control
2. Shade thinning

Why prune?

- To control the shape of the tree so there is as much leaf area as possible to trap sunlight.
- So the tree does not grow too high or too low, and maintains an adequate number of pod bearing branches.
- To remove dead, weak, damaged, diseased and insect infected branches
- To promote enough air movement through the trees.



pruning knife



bow saw



secateurs

pole pruner

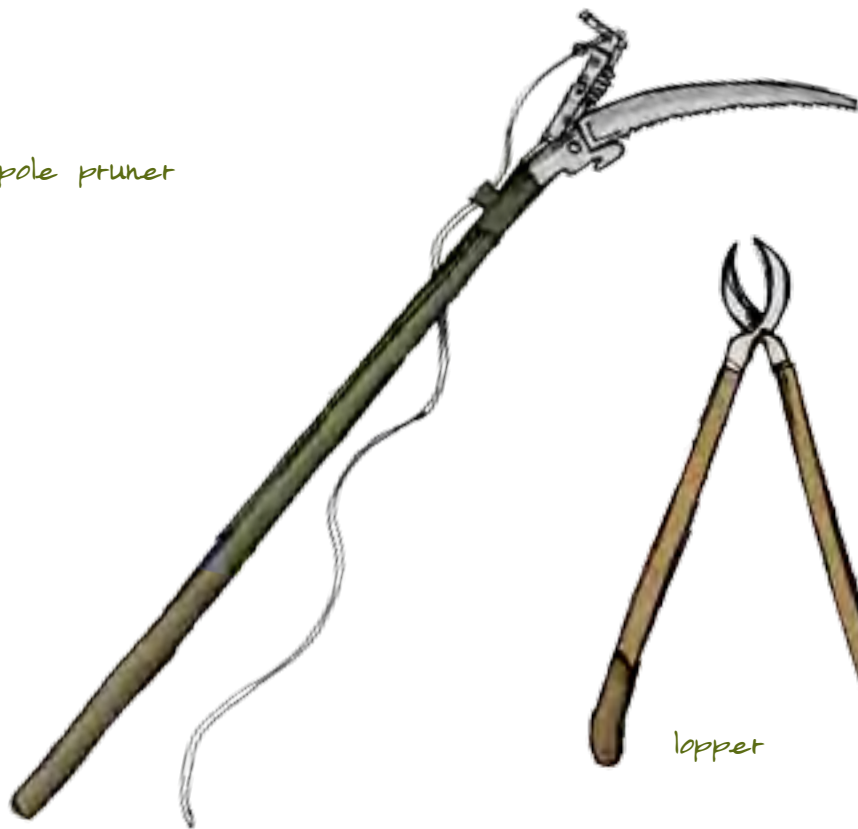

lopper

Pruning tools

Pruning tools used include secateurs, bow saws, pruning knives, loppers and pole pruners.; Small chain saws are also useful for radical height pruning.

Pruning so that trees branch out at the same height.

If a cocoa tree ramifies higher than 1.5 metres it should be stumped back to about 30 centimetres above the ground, and then let a chupon regrow, to a more convenient height. 1.2 to 1.5 metres to jorquette



Cocoa trees with too much shade will have elongated stems and ramify too high. Some trees will ramify too low (or below 1 metre) these can also be stumped back and encouraged to ramify higher by allowing more shade.

If a tree falls over, a new chupon can grow up from the base, and the main tree trunk sawn off later.



Prune a fallen cocoa tree to one chupon to get another tree

Pruning to improve light penetration

Assess the amount of light reaching the cocoa canopy. Not enough sunlight will encourage pests and diseases and reduce pod production. Too much direct sunlight can damage the tree bark and flower cushions.

Thin out and prune the shade trees first before moving onto the cocoa.

At least 10-15 % of light should be filtered by shade trees in mature cocoa.

Cocoa tree leaves need about 75% direct sunlight to make sugar for production of pods. Some sunlight should reach the bearing area. This is the area on main branches and the trunk where most pods are produced.

5 to 10% light should reach the ground under the cocoa trees.



Timing

It is best to prune cocoa trees shortly after the major and minor cocoa flushes, or peak production periods. Often this can vary from season to season, or area to area, depending on prevailing winds and weather patterns in different locations.

See section on IPDM

Order of pruning:

Always prune the top branches first and then work downwards,

FORMATION PRUNING AND STRUCTURAL PRUNING

Develop 4 to 5 main fan branches and secondary fan branches for leaves to trap as much sunlight as possible

Height pruning

Prune to achieve a total tree height of about 3.5 metres to 4 metres. Prune any long high dominant branches back to a side branch.

A dominant branch is one which grows taller than the rest and takes sunlight away from the rest of the tree. Prune them off square with a main branch (right).

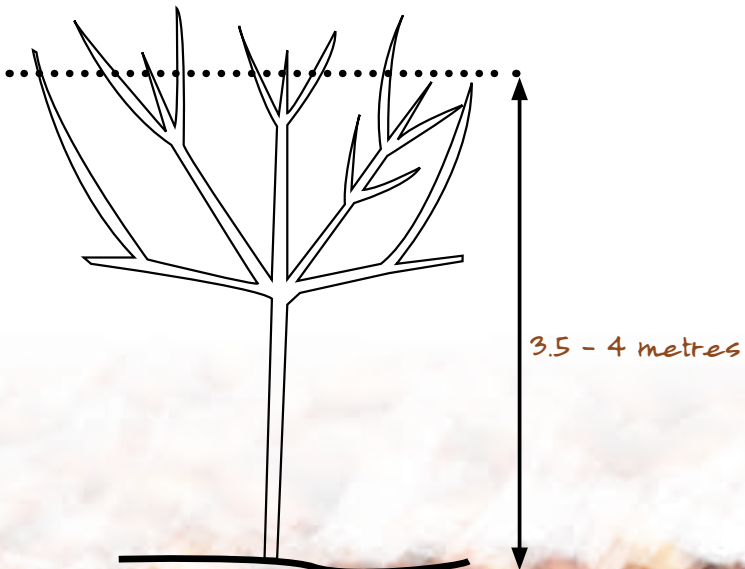

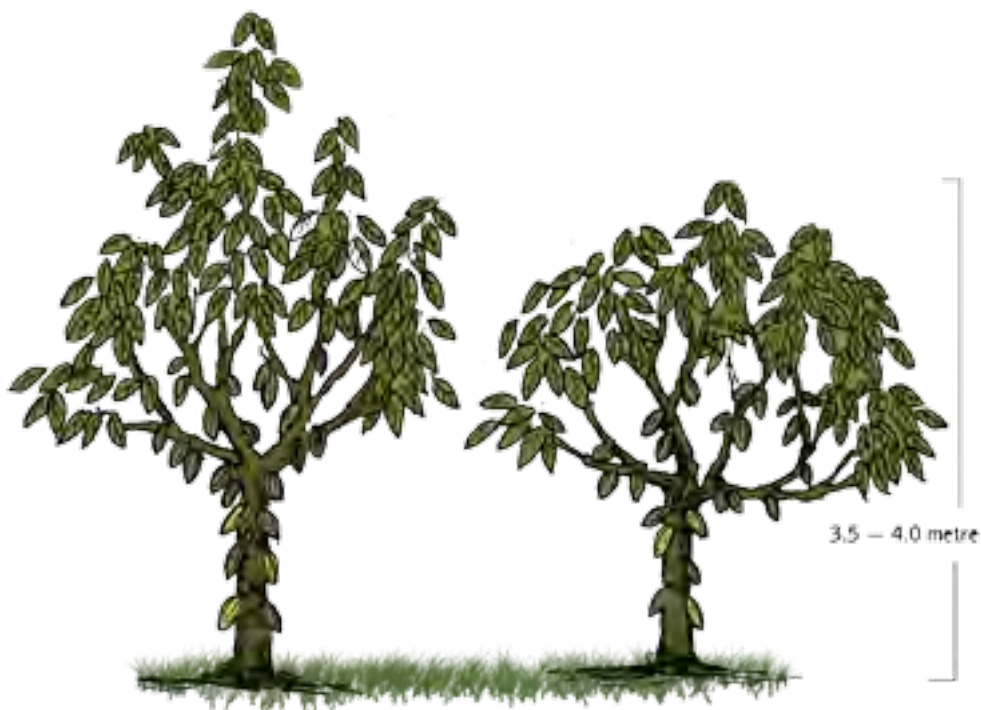

Height prune trees to about 3.5 metres (12 Feet) tall.

One branch should always be left to shade the middle of the tree from direct sunlight, or damage to the flower cushions and bark can occur and the tree will be less productive.

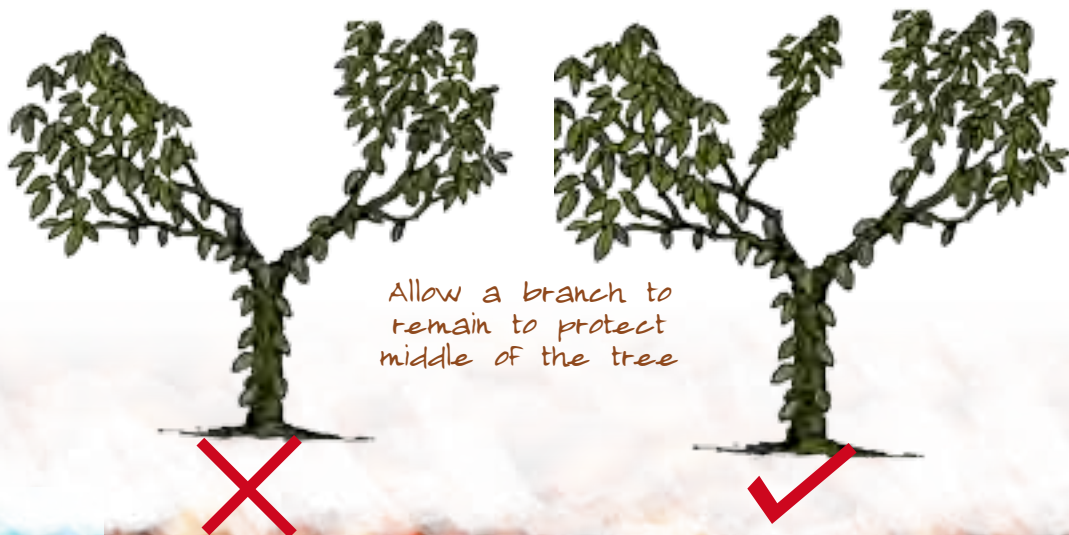

Prune inner jorquette area

Prune off branches inside the jorquette area to improve air flow and provide room for the bearing area.

Any small branch within 40 to 60 centimetres from the jorquette should be removed. 40 cm for younger trees and 60 cm for larger trees.

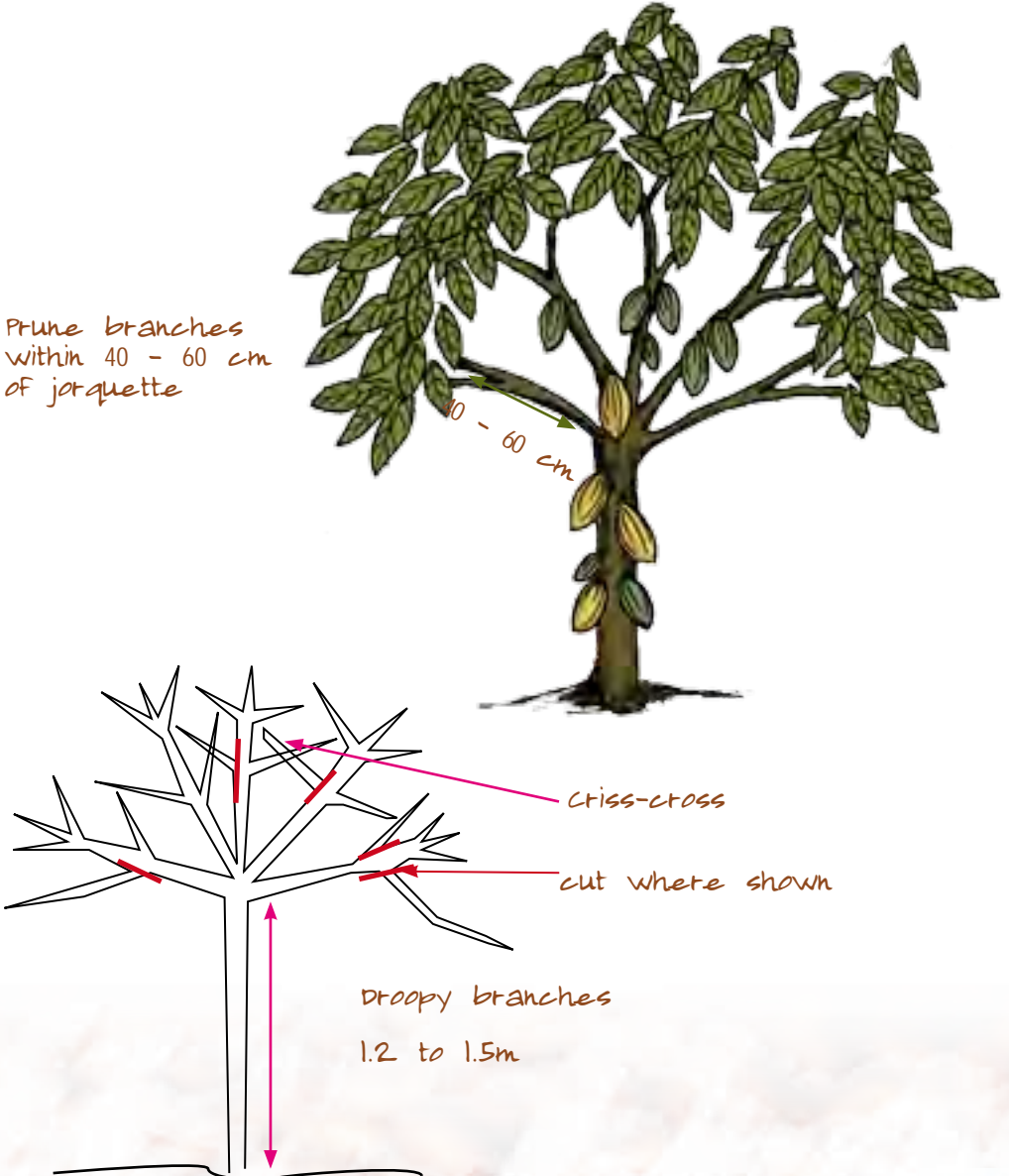

Skirt Pruning

Prune off all branches that droop below the jorquette. This will lift the branches up to a minimum of 1.2 to 1.5 metres high.

Prune criss crossing branches

Branches within the tree which cross over each other need to be removed for air flow and bearing space.

Prune crows feet branches

Small branches growing from previous pruning sites need to be thinned to only one branch for air flow and to better manage interlocking branches from neighboring trees.

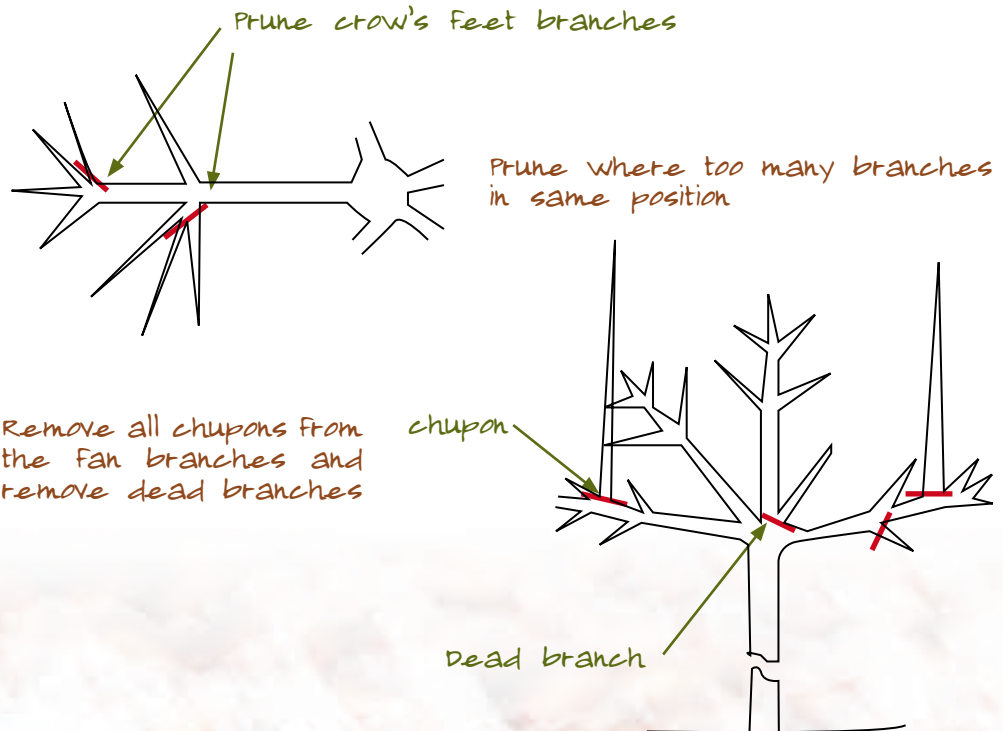

Tip prune

Tip prune when branches are interlocking with neighbouring tree branches. Leave a 10 -20 cm gap between branches of neighboring trees for air flow and sunlight penetration.

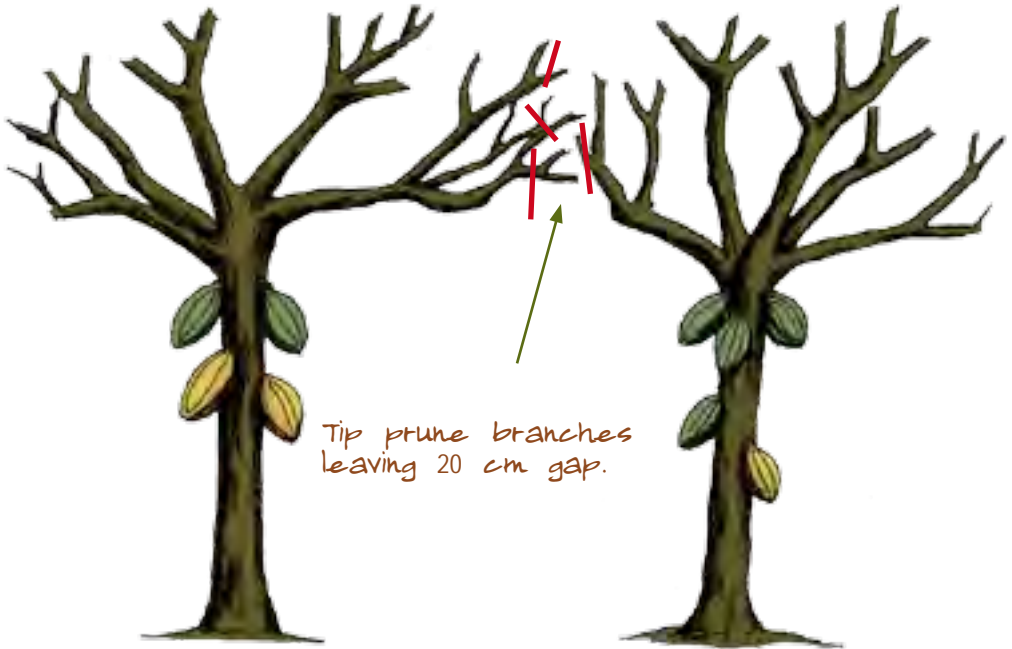

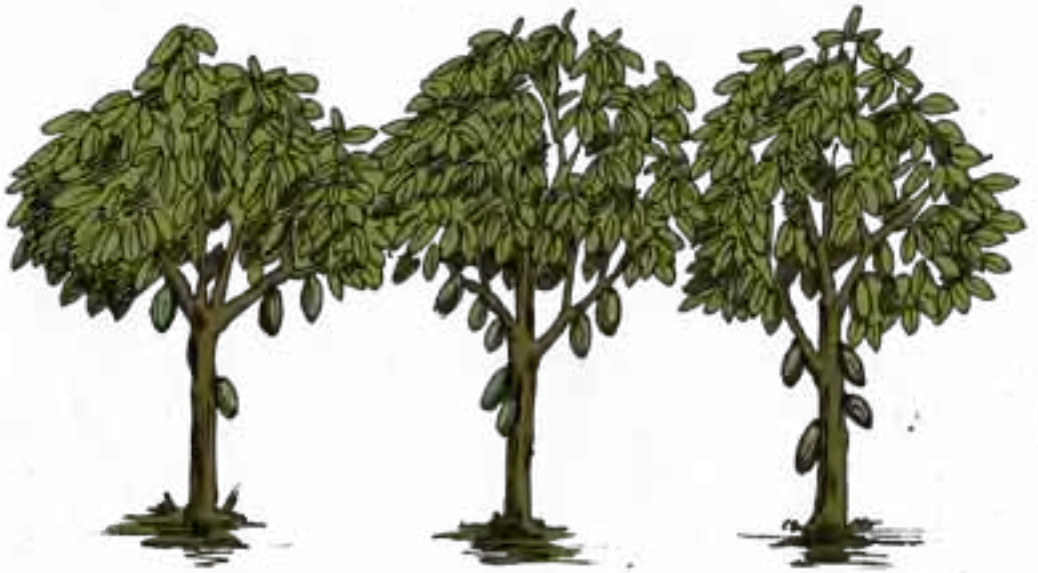

Before tip pruning



After tip pruning

Preferred canopy shape

Chupon, (water shoot) pruning

A popular name for chupons is stilman, because they steal water and nutrients from the tree so they need to be removed

If chupons are young they are soft and easy to prune with a sharp pruning knife, flush with the main trunk or branch so prune chupons as regularly as possible.

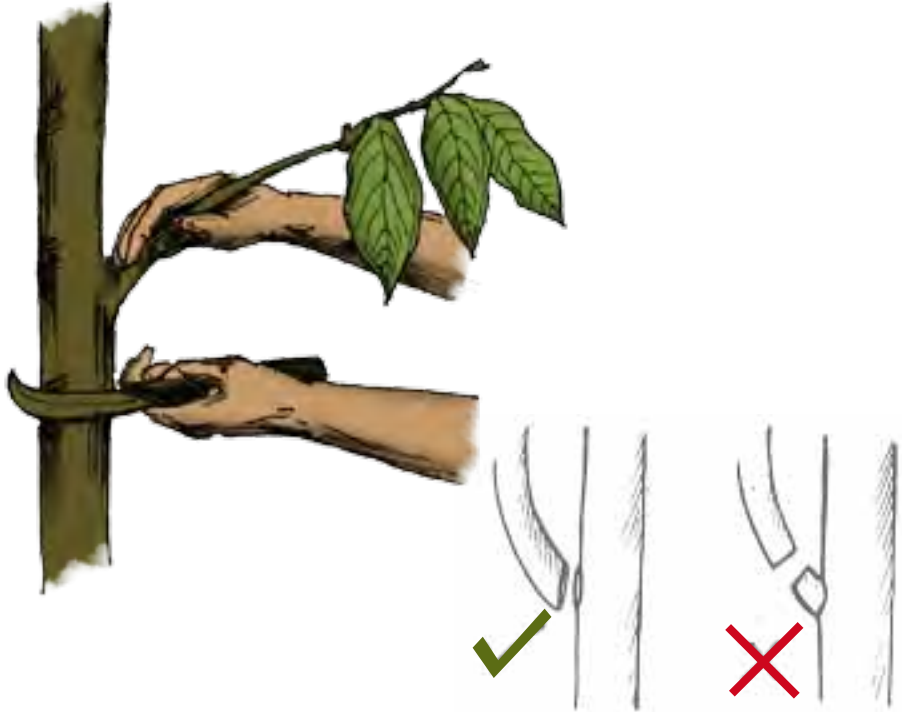

Stub Ends

Don't leave stub ends. Branches should be pruned straight with main branches or dead stubs left will be an entry point for Giant Cocoa Termites

COCOA REHABILITATION

OLD COCOA

Many cocoa farms in Solomon Islands are overgrown, over shaded and over 30 years old. Old cocoa trees take up good land but produce few pods and the black pods high in the canopy of the big trees often give black pod disease to the pods below them.

Before rehabilitating existing farms first reduce the number of shade trees, and remove shade tree branches to allow 75% light penetration to cocoa trees.



Old cocoa needing rehabilitating

SELECT THE BEST REHABILITATION STRATEGY

Farmers should not cut down or rehabilitate all the old cocoa trees at once because they will have no income. Cocoa farms should be rehabilitated in sections, so some income is still received during the process

- Assess which area to rehabilitate first.
- Decide whether to stump back all the old trees and let them regrow. It is better to stump back all trees if there are a lot of gaps in the block and the farm is over 20-25 years old.
- If there is a full stand of cocoa trees that are younger than 20 -25 years old, gradually height prune all trees back to 3.5 to 4 metres.
- You should reline and replant all gaps in the cocoa farm with nursery seedlings, or by direct planting.



Plan which trees to replant, stump back, or height prune



Two strong chupons growing back from a stump

Stump back old cocoa trees and allow one strong shoot to regrow near the base of the stump. It will put new roots into the soil and have a strong join to the old stump. Cut up and leave branches from the old tree to dry and rot mid row.

If new shoots grow from an old stump, and new seedlings planted in the gaps grow, reduce the shade after nine months.

Manage the new cocoa trees using standard management practices such as ring weeding, slashing, and pruning. After about 12 to 18 months they should be back in production.



cutting up old trees, and branches



Pruned branches used as firewood or left to rot mid row

Radical Height Pruning

Radically height prune trees using a ladder and small chainsaw, pole pruner or bow saw.

Radical pruning should be done in two to three stages over a period of 6 to 18 months, eventually reducing the tree to a manageable height of 3.5 to 4 metres.

Radical pruning is best done after the peak cocoa harvest period, usually from August to October.

Do a follow- up prune 6 months after the first pruning by selecting the best fan branches to form a new canopy, and then thinning out other fan branches.

Radical pruning will encourage many new chupons to grow. Continue to remove chupons at least every month. If this isn't done, chupons will quickly regrow and form another high canopy and your radical pruning would have been wasted.

Do not over prune and leave the middle jorquette and main branches exposed to direct sunlight. This will damage the bark and flower cushions. Leave a fan branch to protect the middle of the tree.



*Radical height pruning
with a small chainsaw
Leave a cover over
the middle of tree*

FERTILIZER

Fertilizer is expensive and may not help improve cocoa production. Its use in the Solomon Islands is optional.

Do not apply fertilizer to cocoa which is over shaded and needs pruning, Always thin shade, prune and ring weed before applying fertilizer. otherwise more growth and no more production will be the result and the fertilizer and your money will be wasted.

Only apply fertilizer to young, well managed trees to obtain and maintain high production.

Before applying fertilizer, clear all leaf litter and weeds from a metre ring around the tree. After the fertilizer has been applied, rake the leaf litter back covering the fertilizer.

It is best to apply fertilizer before light rain. Do not apply fertilizer during a hot and dry period or during heavy rain as it will be wasted.

The fertilizer recommendation for a young cocoa tree over 18 months old is 240 grams of NPK (half a large family (Solomon Taiyo tin) every three months.)

Urea is a nitrogen fertilizer that can be applied to young trees if leaves are yellow and the tree is growing slowly. 100 grams or 1 quarter of a tin fish every three months.



FURTHER RECOMMENDATIONS

Do not apply fertilizer to cocoa trees younger than 15 months unless deficiency symptoms are present, such as yellowing, browning of boundaries of the leaf, or other leaf discolouration.

In clay over limestone soils such as Malaita, apply Muriate of Potash at 200 gram per tree after planting and after one year old, and then 400 to 600 grams per tree at yearly intervals.

For other soil types use the NPK recommendation mentioned above.

Other soil types may have trace element deficiencies. If cocoa leaves are discoloured or misshapen, consult your MAL Extension Officer for more information and advice.

PRODUCTIONS

Expected smallholder amelonado cocoa production in kilograms per hectare if maintained properly.

Year from Planting										
0	1	2	3	4	5	6	7	8	9	10-25
Dry bean yield (kg/ha)										
Plant	Main-tain	Main-tain	150	500	1,000	1,200	1,200	1,200	1,200	1,000
Wet bean yield (kg/ha assuming 35-45 % recovery)										
Plant	Main-tain	Main-tain	330-375	1,100-1,250	2,200-2,500	2,600-3,000	2,600-3,000	2,600-3,000	2,600-3,000	2,200-2,500

HARVESTING AND PROCESSING

HARVESTING

Harvest ripe cocoa pods every week during peak production periods or every 2-3 weeks depending on the number of ripe pods. Discard all damaged and diseased pods.

Pods should be ripe and beans should be free of black pod and damage from cockatoos, rats and flying foxes.

cockatoo



Flying Fox



Pod damage

rat



These pests mean less cocoa.-harvest pods regularly to avoid losses

Cut or hook pod

Cut or hook off pods with a sharp knife or cocoa hook. Don't pull and twist the pods off, or you will damage flower cushions and allow canker disease to enter the tree.



Hook off ripe pods with a sharp cocoa hook



Use a sharp knife or hook



Don't twist off

Breaking pods

Pods should be broken immediately after harvest or kept no longer than one week before breaking.

Carefully break pods open without damaging beans inside. Use a blunt object to avoid cutting the beans. Place the beans on clean leaves or in a clean container.

Do not break pods while it is raining or the sugar in the beans will wash off and affect fermentation.

Discard any beans that are damaged by black pod, or are under or over ripe, or are discoloured

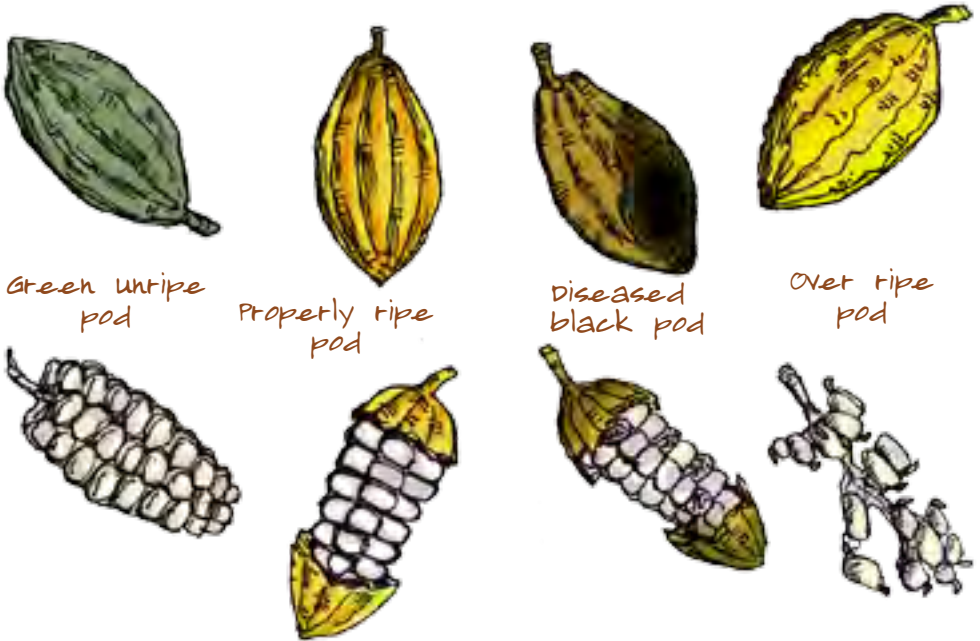



Break pod



Remove beans from placenta



Discard overripe beans

Selling wet bean

Farmers who are near a village fermentry or near a road with wet bean buyers can sell their wet bean. This will provide money quickly, and is the best option for farmers with only small cocoa farms, or in the non peak production periods where only small amounts of cocoa is produced.

The wet bean needs to be clean of foreign matter such as stones etc. Cocoa will not ferment properly if beans have been soaked in water before sale.



Fermenting

In Solomon Islands, wet bean cocoa is fermented in wooden boxes. Fermenting cocoa develops a good chocolate flavour which the international market prefers. Don't ferment cocoa in bags, canoes, or in a hole in the ground. This will cause poor quality.

Wet beans should be placed in a wooden fermenting box within 24 hours of breaking. Don't mix beans from pods broken at different times and don't add wet beans to a ferment after the second day when a ferment has started.

Wet bean needs to be at least 40cm deep in the box, otherwise the cocoa will remain too cold and wont ferment properly. Also it should be no more than 60 cm deep for air to get into aid the fermentation.

After the beans are placed in the box, the wet bean must be covered with banana leaves then clean sacks. Do not use plastic as a cover as it prevents air getting in. Clean the boxes between ferments. The slits or holes in the bottom of the box should be cleared of mucilage and rubbish between every turning.

The cover keeps the heat of the fermentation.

A large 1 metre x 1 metre fermenting box filled to 60 cm deep needs about 500 kg of wet bean. Wooden dividers in the box can be used for smaller quantities of wet beans



Cocoa beans must be fermented in wooden boxes for 6 to 7 days to produce good quality cocoa.

In the first 24 hours of fermentation excess water drains through slits in the bottom and sides of the box. In days 2 and 3 the beans start to heat up. (They remain hot (45 to 50 degrees centigrade until the end of fermentation in day 6 or 7.)

Turning

The beans must be turned once a day, every day, to allow air into the middle of the mass and to break up clumps of beans.

The beans in the middle of the fermenting mass should be mixed with beans from the corners and sides to get an even fermentation.

Drainage holes or slits in the bottom of the box should be cleaned every time the beans are turned.

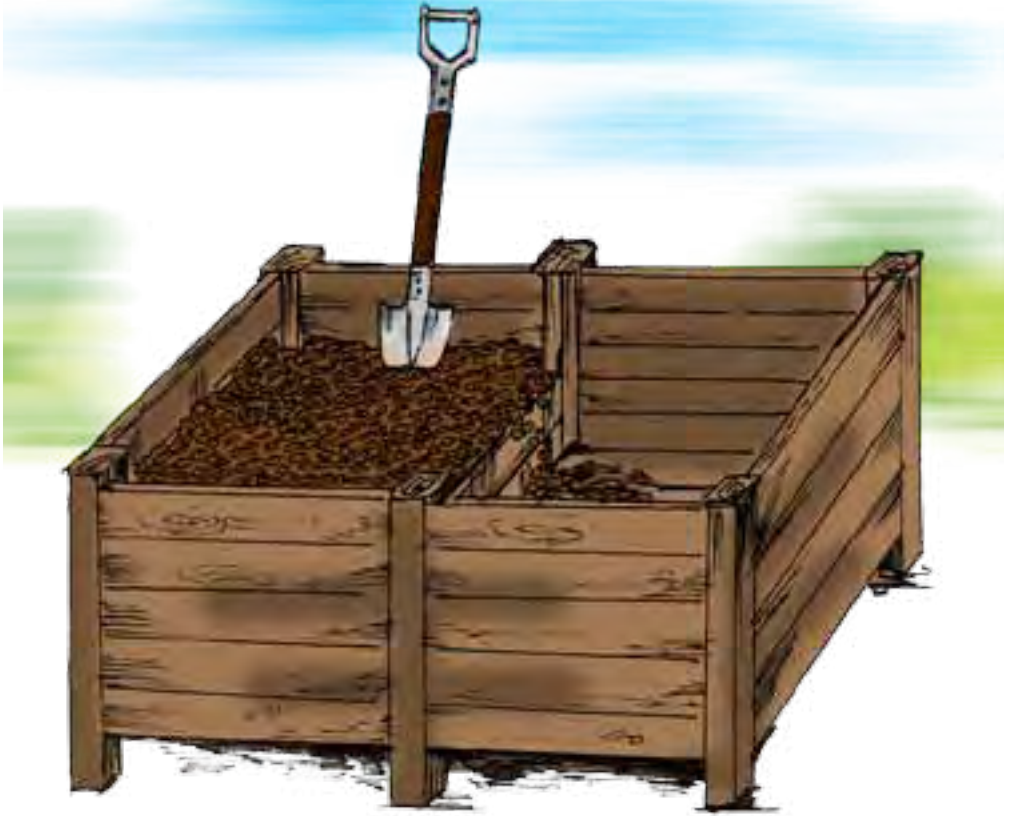

Are the beans properly fermented?

After day 6, randomly select a few beans inside the fermenting mass and cut them in half.

If they are fully fermented the bean will be brown on the outside while on the inside they will be turning from purple to brown and there will be a brown fluid inside. They will also have the rich smell of fermented cocoa, and the cotyledons (segments of bean) inside the shell will be open.

If the beans smell foul, and are turning black on the outside and attracting blue flies, it means they have been left too long in the fermenting box and are going rotten, or the amount and depth of beans was too small for a good ferment. The buyer will reject this cocoa.

Typical changes in appearance and colour of cocoa beans during fermenting and drying

fermenting

fresh ripe cocoa beans fermented for seven days and turned every 24 hours



fresh wet bean
Soft wet sweet mucous surrounds bean. Cotyledons moist. Cut surface is purple, damp and firm. Bright white radicle.



day 1
Mucous becomes discoloured. Cotyledons start separating. Radicle starts brown.



day 2
Cotyledons separate more. Traces of purple liquid between cotyledons. Radicle brown.



day 3
Cotyledons separate more. Skin and mucous become browner. Radicle same colour as cotyledons.



day 4
Purple-brown stain under skin. More liquid between cotyledons. Mucous is slimy, not wet, and skin is light brown.



day 5
Brown-purple colours develop. Brown liquid under skin and between cotyledons. Skin is an even mid-brown colour.



day 6
Cut surface purple-brown or brown. Brown liquid distinct on cut surfaces. Skin darker brown. Mucous sparse and sticky.



day 7
Cut surface deep purple-brown or brown. Skin darker brown or black-brown. Some white mould on beans in corners & base of box.

drying

beans dried over two days using a combination of kiln pipes at moderate heat (average 60 - 70°C) and solar drying, with an overnight rest period

day 8



Colour of cut surfaces varies from deep brown to brown-purple. Skin dry but some residual moisture in cotyledons. Moisture content 5-12%.

day 9



Cotyledons open and without visible moisture. Skins dry and brown to brown-black. Moisture content 6-7%.

Drying

The next step in cocoa processing is drying the fermented beans. Before drying the beans, ensure that the dryer is in good condition and there is enough firewood available. Some firewood burns too hot and is less suitable.

Before placing the beans on the dryer bed, start the fire and heat up the dryer.

Spread out the fermented beans on the dryer bed.

Beans should be kiln dried for the first 12 hours. If not beans will keep fermenting and go rotten. Usually fermentaries kiln dry beans over night.

The next morning they should undergo a resting period from the fire for several hours so moisture equalizes from the middle of the bean to the outside. If there is no resting period, the beans will be over dry on the outside but still too wet inside. Sun drying during the day is a good option if the dryer has a sliding roof.

It is important to turn over the beans on the dryer bed every half an hour, so that beans on the bottom and edges get moved to the top and centre and drying is even through the mass of beans.

The drying process should not be continuous, and should take place over two days or 48 hours.

Don't use the dryer for other purposes such as drying copra, beche de mer, chillies or kava. These will contaminate the cocoa.

The moisture content of the dried beans should be no more than 7 % and not less than 6%.

Checking if beans are dry

Once the beans have cooled down, squeeze a bean between your thumb and forefinger. When the beans are properly dry they are no longer rubbery. They will crack when squeezed and the bean will break into pieces with the cotyledons intact.

If the bean shell shatters the cocoa has been over dried.

If the beans are properly dry they will make a crackling noise if a handful are squeezed. Make sure beans are cooled down and moisture equalized in the bean before doing this

COCOA DRYERS



There are many different designs for cocoa dryers. A good type of dryer is a hot air dryer with a sliding roof which uses the sunshine during the day to help dry the cocoa so a good quality cocoa is produced using less firewood.

Cocoa dryers in Solomon Islands are hot air dryers, or dryers which use a kiln pipe and fire underneath a bed of cocoa wire mesh.

It is important to have a kiln pipe and flue pipe (chimney) which isn't rusted through with holes, as this produces smoky cocoa which is poor quality and hard to sell.

TYPES OF DRYERS IN SOLOMON ISLANDS

Kukum Dryer

A common dryer in Solomon Islands is the Kukum dryer, shown below which makes use of a kiln pipe, dryer bed and cement impregnated hessian sacks on the dryer bed sides.

Kukum dryer over view

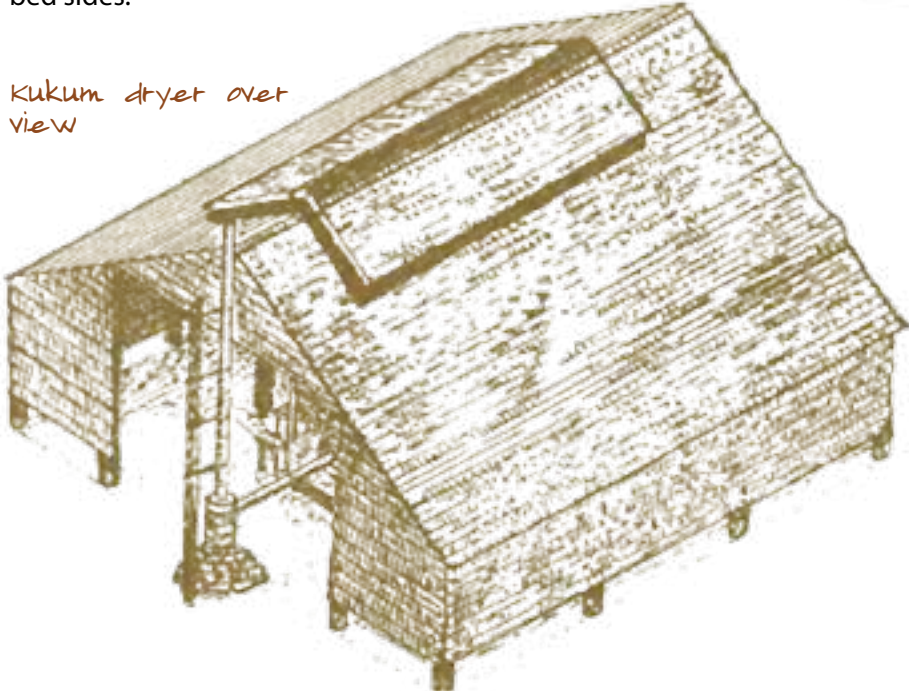

Kukum dryer end view

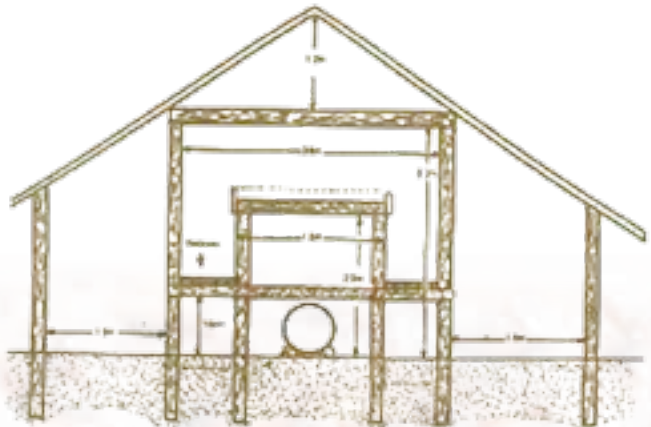

DETAILS ON THE LAYOUT OF DRIER FLUE BURNER AND CHIMNEY

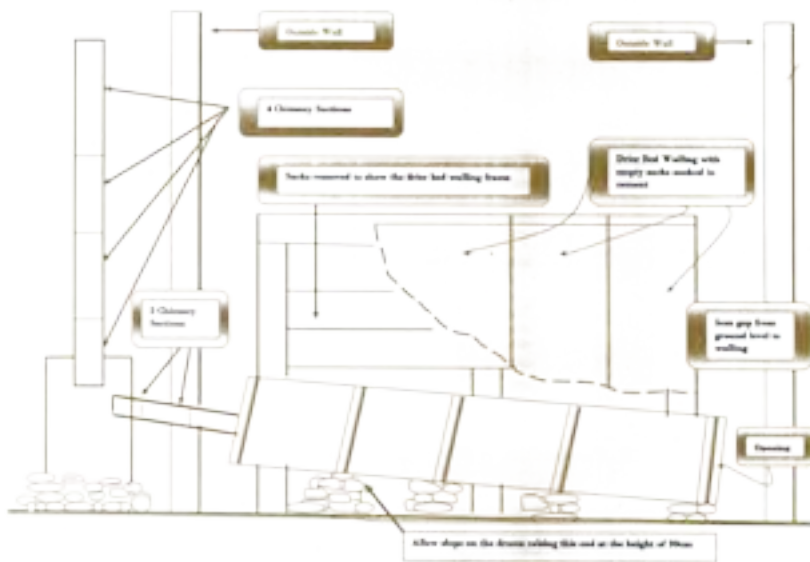

Kukum Dryer side view

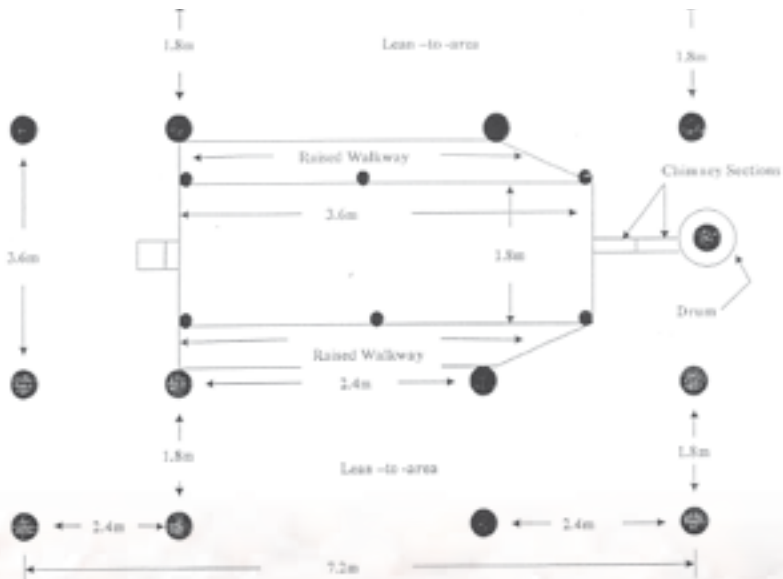

Floor Plan of Kukum Dryer

Mini Dryer

Another dryer which is suitable for smallholders is the mini dryer. It is designed to handle smaller amounts of cocoa bean in the fermenting box and dryer bed.

Mini dryers have been used a lot in Bougainville, and are popular with smallholders because it produces good quality dry bean cocoa and a better income than just selling wet beans.

They are fabricated with a metal frame which enables it to be disassembled and transported and quickly reassembled on smallholders farms. This makes it ideal for remote isolated areas where there is a lack of wet bean buyers

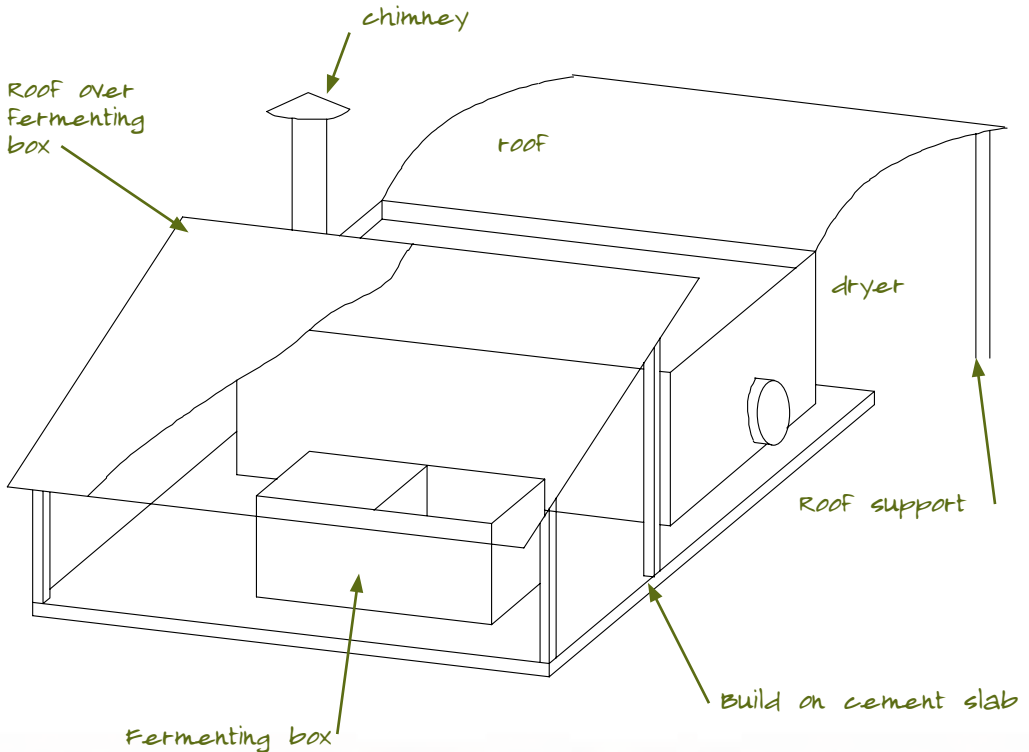

Mini dryer

GRADING

Discard dried beans that are flat, black, insect damaged, or have internal mould. Pieces of placenta, pod husk and any other foreign matter should also be discarded. A grading tray can be used to make it easier to find faulty beans and foreign matter. Double beans (beans stuck together) should be broken apart.

Faulty beans are shown in the pictures below.
Discard all but well fermented and dried beans.



Flat bean



Germinated bean



Insect damaged



Internal mould bean



Internal mould bean



Over fermented

slatey



Partially slatey



Purple bean



Fully fermented

BAGGING

Dried beans must be left to cool down before bagging in a clean new jute bag or sack. Each bag should contain 62.5 kilograms of beans.

The bag itself weighs 1 kilogram, and 16 bags will make a tonne of cocoa.

Beans should have no more than 7% moisture content. Check beans for dryness as previously discussed.

You must stencil your bags so buyers, exporters and manufacturers know where the cocoa has come from.

The stitching along the top of the bag should be close together to prevent beans falling out.

STORAGE

The shed used to store full cocoa bags should be located in a well drained dry location. Bags should be stored on pallets under a waterproof roof. The shed must be secure against theft, rats, and other animals.

Don't store cocoa with copra or fuel otherwise their smell will contaminate the cocoa. Cocoa stored more than a month must be dried before sale to exporters.

Don't handle the bags roughly or sit on them as this will damage the beans inside



cocoa bagged and put into storage

TRANSPORT

When bags are transported they should be covered with a canvas to prevent sea spray, rain and dust getting on them.

RECORDS

It is good management practice to keep records of all farm activities and financial transactions relating to your cocoa enterprise. Weigh your bags of cocoa before they go to the buyer so you have an independent record of the weight of beans you are selling.

MARKETING AND EXPORT

The cocoa is sold to an exporter who finds a market for the cocoa overseas. He organizes the cocoa to be placed in containers and shipped to the buyer overseas.

It is important for Solomon Islands to export good quality, well fermented, and well dried beans without foreign matter in the bags, so our cocoa has a good reputation on the world market.

If the quality is good, farmers will get a better price, and cocoa will be easier to sell when the world market is oversupplied.



MANUFACTURING

Cocoa is roasted and ground in factories overseas and made into products such as cocoa liquor, cocoa powder, and cocoa butter. Sugar and milk are then added and mixed together to make chocolate and products like Milo which are sold throughout the world



Milo, a cocoa product

PEST AND DISEASE CONTROL

Many pest and diseases affect cocoa. The best method of dealing with these problems is to manage the cocoa farm well, including weed maintenance, adjusting shade levels, pruning cocoa properly, and using biological controls, e.g. green tree ant (*Oecophylla*, "Ekofla") and crazy ants (*Anoplolepis*) that reduce pests like *Pantorhytes* and *Amblypelta*

IPDM

IPDM" standing for Integrated Pest and Disease Management, (IPDM) is a system of managing the cropping cycle where the best conditions are developed for the crop to grow and produce well. IPDM means understanding the tree and understanding the causes of pest and diseases and intervening to achieve maximum production.



IPDM is also all about understanding and using the relationship between the cocoa tree, the environment and the seasons. A management plan can be put in place like the one shown next.

WHAT IS INTERGRATED PEST AND DISEASE MANAGEMENT ?

Integrated Pest and Disease Management (IPDM) of Cocoa is a strategic approach to improve your production by managing all aspects of your cocoa tree. To get the most from your cocoa tree, you need to consider the environment in which your cocoa is growing, the pest and disease living in your area and type of cocoa material you are planting.

The IPDM strategy aims to manipulate the relationship between your tree, the environment and pest and diseases at the most appropriate time so that it favours the maximum production.

Strategy: The key points about the strategy are:

1. The management inputs are to be applied together and not individually, because the complete input combination gives the best significant outcome. The management is called IPDM when all inputs are applied as intended. When one component is missing, you should not expect to get the maximum yield from your cocoa farm.
2. When it is the period for applying the IPDM inputs, it is advisable for all cocoa farms in the your area should receive the IPDM inputs because of the communal nature of cocoa pests and diseases. If all apply the IPDM inputs and one farmer does not, it is likely to affect the spread of pests and diseases to clean cocoa blocks.
3. For managing cocoa using the IPDM strategy, the starting point is using good planting materials. The material should be: high yielding, produce good quality beans and should be resistant to pests and diseases.

Timing: The timing is important so that the pest and diseases of cocoa are manipulated at the time when they are at their weakest point in their life cycle and when the cocoa is highly receptive to inputs.

The inputs are designed to be applied twice a year, one is a major input period after the major peak harvest and the other is a minor input period after the minor peak harvest.

The IPDM activities: The IPDM inputs activities should be carefully carried out so that the trees are not badly damaged

Management Inputs at best time in crop cycle

This can vary from season to season and location to location

Input application months	Flower & Fruit setting months	Peak Harvest months
Heavy activities August, September & October	October, November, December & January	Major harvest April, May, June & July
Light activities January, February & March	April, May, June & July	Minor harvest October, November, December & January

Light Activities

- Slash & ring weed 1 m diameter
- Selective shade pruning to allow 75% sunlight to cocoa leaves
- Create 10-20 cm gaps between trees
- Prune off droopy canopies to start at 1.2m -1.5m above ground
- Removal of chupons
- Selective Pest and disease control and tree sanitation

Heavy Activities

- Slash & ring weed 1 m diameter
- Selective shade pruning to allow 75% sunlight to cocoa leaves
- Create 10-20cm gaps between neighboring trees
- Prune off droopy canopies to start at 1.2m -1.5m above ground
- Removal of chupons
- Pest and disease control and tree sanitation
- Height reduction to 3.5-4m, with structural and formation pruning

CHEMICALS

Chemicals are useful for controlling pests and diseases but they are expensive and are ineffective if incorrectly applied. They are also poisonous, and can harm people, animals and the environment if not carefully used.

Some people prefer not to use chemicals. Cocoa produced without chemicals is called **organic cocoa**.

SAFE USE OF CHEMICALS

It is very important that farmers who use chemicals are fully aware of how to use them properly, (following the correct dose rates, and using protective clothing including gloves, goggles, hats, and boots.)

Use safe storage of any chemical containers away from children and animals. Dispose of empty containers by burying them far from water sources.

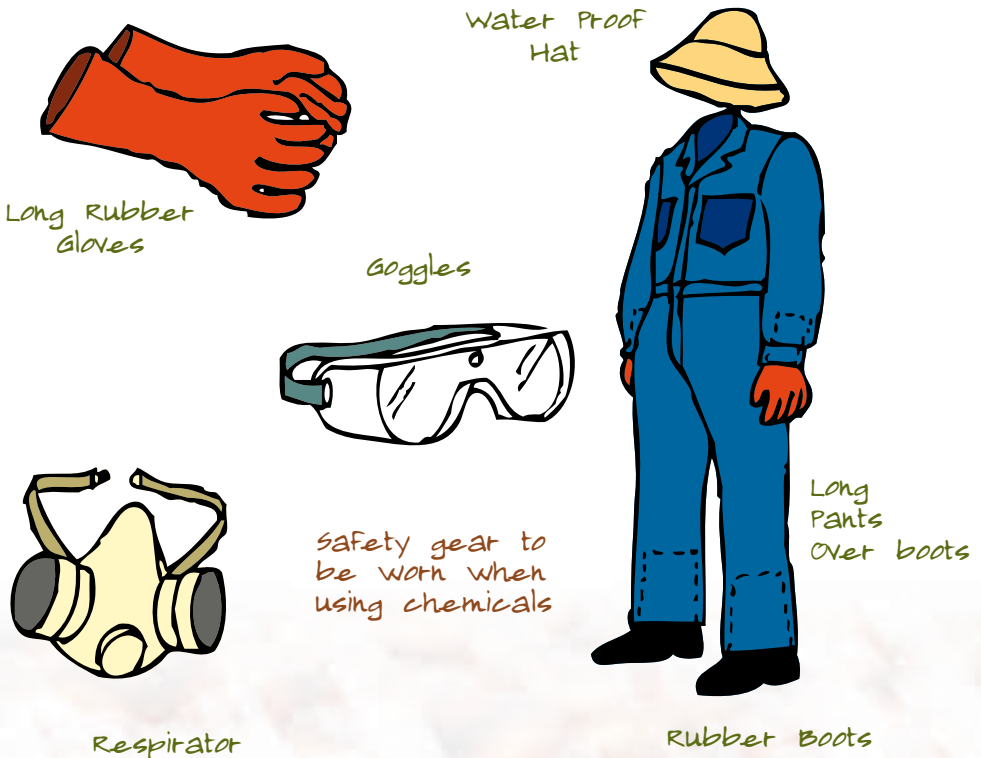

COMMON COCOA INSECTS

WOOD BORERS

Pantorhytes weevil



Pantorhytes grub



Pantorhytes adult

Description

The adult *Pantorhytes* is a large weevil (about 1.5 to 2 cm long) while the larvae is short and fat (1-1.5 cm).

Frass (or faeces), saw dust and rubbish which comes out of a hole tells you there is an active grub inside. The frass is a brown, moist, and the bore hole goes straight into the trunk or branch of the cocoa tree.

Damage

Pantorhytes adults lay their eggs in the bark of cocoa trees. When the grubs hatch out, they bore into the trunk or branches of the tree and weaken it.

These holes are an entry point for canker disease, which can eventually kill the tree.

Adult Pantorhytes also chew the bark off young shoots and branches, stopping growth in seedlings and young trees.

Old cocoa trees or forest trees left in or near a farm of newly planted cocoa, can act as a source of adult Pantorhytes infection

Control

Pantorhytes is usually not a problem where coconuts have been used as shade.

Collect all adult Pantorhytes (found underneath leaves in the heat of the day) and kill them.

Use a flexible piece of wire to carefully remove grubs from their holes. Do not use a knife to cut out the grub as this will damage the bark and may do even more harm to the tree.

Biological Control- Crazy Ants (*Anoplolepis*) and Green Tree Ants (*Oecophylla*)

Crazy ants chase away adult Pantorhytes or kill them, and they eat the eggs laid in cracks on the bark. Use pieces of bamboo with a few ripe cocoa beans inside, to attract the ants. Place the bamboo on the ground in an area where there are a lot of ants. Put leaves into the mouth of the bamboo.

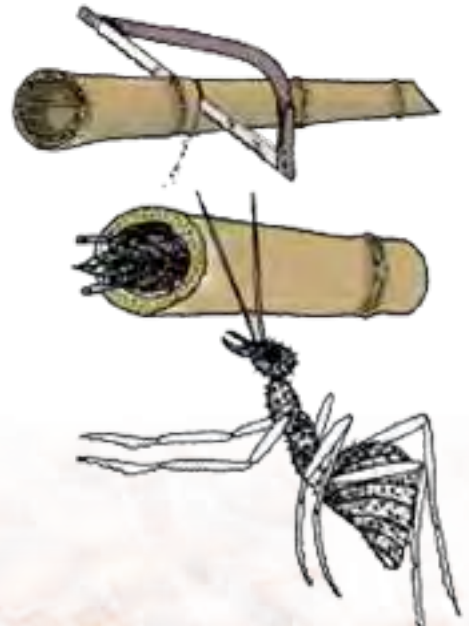

*crazy ants 10 times actual size,
nesting in prepared bamboo*

When the bamboos are full of ants nesting, seal them and carry them into the cocoa farm and lay them around the base of cocoa trees. The ants will colonize the new farm area and help protect trees against Pantorhytes.

Green tree ants (sometimes called Large Yellow Tree Ant or “Ekofla”) can also control Pantorhytes. They can be introduced by planting soursop trees around the block and using bush rope as a bridge from the soursops to the cocoa trees.

Fire Ants

The small fire ants found in Solomon Islands are a nuisance to farmers trying to manage their cocoa; but they also help to control damaging insects.

To reduce the bites and irritation from fire ants, wear a broad brimmed hat while working under the cocoa canopy to protect your eyes and skin and wash any areas of your body that are in contact with the ants.

Fire ants are less active in the rain, making this the best time for pruning.

Chemical control of Pantorhytes

Use a wire brush to clean any frass out of bore holes.

Paint the larvae bore holes with a mixture of;

- 45 ml Karate
- 250 ml White Oil
- 15 grams Ridomil (for canker control)

If the Pantorhytes infestation is severe, consider spraying the adults in the tree canopy with the following mixture..

- 28 ml “Decis/Karate” 2.5% EC
- 2 ml surfactant
- 10 litres water

Karate is a toxic chemical so gloves and a face mask must be worn when painting bore holes.

Longicorn

Description

The adult longicorn can fly some distance between various host plants in the bush, including some fruit trees. The grub has a large head and tapered, segmented body.

Longicorn adult

Longicorn grub damage

Longicorn grub

Adult longicorn and grub
damaging tree

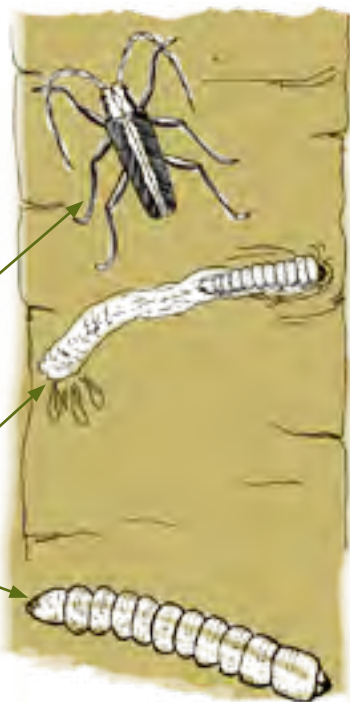

Damage

The longicorn adult lays its eggs in the bark of cocoa tree and when the grub hatches out it bores into the tree, under the bark. Longicorn grubs can completely ring bark a branch or the trunk of a tree. A lot of frass (saw dust, and sap to ooze from the bore holes).

Longicorn grubs can be particularly damaging to a stand of newly producing cocoa trees by creating bore hole damage and an entry point for canker disease, causing further damage and sudden tree death.

Control

Regularly check your cocoa trees for Longicorn damage.

Longicorn adults like dark, moist conditions to lay their eggs. Practices such as ring weeding and pruning can limit the problem. Slashing around the base of the tree can also prevent the adult laying its eggs.

Do not cut the grub out with a knife or you will harm the tree. A flexible piece of wire can be used to push into the bore hole to kill the grub.

Chemical control

A wire brush should be used to first clean the bore hole.

The bore hole should then be painted with a mixture of:

- 45 ml Karate
- 250 ml White oil
- 15 gram Ridomil (for canker control)

Karate is a toxic chemical so gloves and a face mask must be worn when painting bore holes.

Web worm (Pansepta)

Description

Pansepta, or web worm which it is commonly known as, is a moth. The larvae is a grub about 1-2 cm long.

Damage

The Pansepta moth lays its eggs on the bark of the cocoa branches. The grub eats its way into the branch, leaving a web from its frass.

The grub usually attacks relatively small branches (1 – 5 centimetres in diameter.) and trees up to 4 years old.

The growth of infected trees is restricted and branches that have been attacked will die.



Pansepta moth



Pansepta grub



Pansepta worms inside branch



Pansepta web

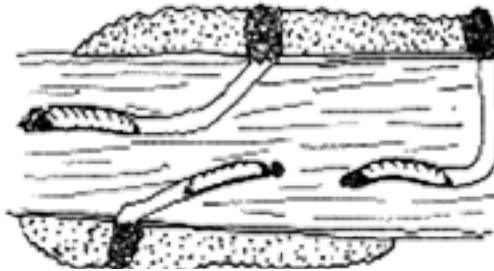

Pansepta worms inside branch

Pansepta worm

Control

Pansepta attack happens when there is not enough shade. The best control is to increase shade levels.

Control should only be carried out if many branches are dying. If only a couple of branches are affected, control is not worth while.

Any control measures should be aimed at killing the grubs in their bore holes. Heavy pruning may result in weakening the tree, and exposing it to further attack, and there is usually little chance of cutting out all the eggs and grubs.

Chemical control

Remove all the frass from the branches, and wipe a chemical mix of Dimethoate (0.6%) solution on the bark of the branch using a swab.

A swab is made by securely wrapping a cloth around the end of a stick and soak the cloth in the Dimethoate (0.6%)

A Rogor 30 solution can also be sprayed onto the infected branches with a knapsack.

- 210 ml EC, (Emulsifiable Compound)
- 2 ml surfactant
- 10 litre water

Giant Cocoa Termites

Description

A termite is a type of ant that feeds on wood. Termites are often found in house posts and frames.

The type of termite that attacks the trunks and branches of cocoa trees is the Giant Cocoa Termite.

The soldier and worker termites cause damage by eating the wood of the tree.

Damage

A termite infestation is often difficult to detect in cocoa until the tree has fallen over, or a large branch has broken away in a strong wind or heavy rain storm.

The bark over the termite nests is soft and spongy.

Younger colonies which have not made extensive nests can only be found by breaking off sections of dry wood.



soldier termite



worker termite

Control

Other smaller species of termites which build tunnels on the outside of cocoa trees can carry black pod spores up the tree and spread the disease. These tunnels should be carefully scraped off with a bush knife.

Control of giant termites:

Control of Giant Cocoa Termites requires regular inspection and pruning of dead wood. Since infestations only occur through dead wood, care should be taken to prune branches as close as possible to the main branch or trunk.

If pruning is carried out correctly, new callus tissue will seal the wound and prevent entry by termites.

Chemical Control

When a Giant Cocoa Termite colony is located, the nest should be opened with a bush knife.



The chemical mixture below can be tipped into the nest.

- 28 ml Decis /Karate,
- 2 ml surfactant,
- 10 litres water

STEM FEEDERS

Grey weevils

Description

The grey weevil is a small (1 cm) weevil.

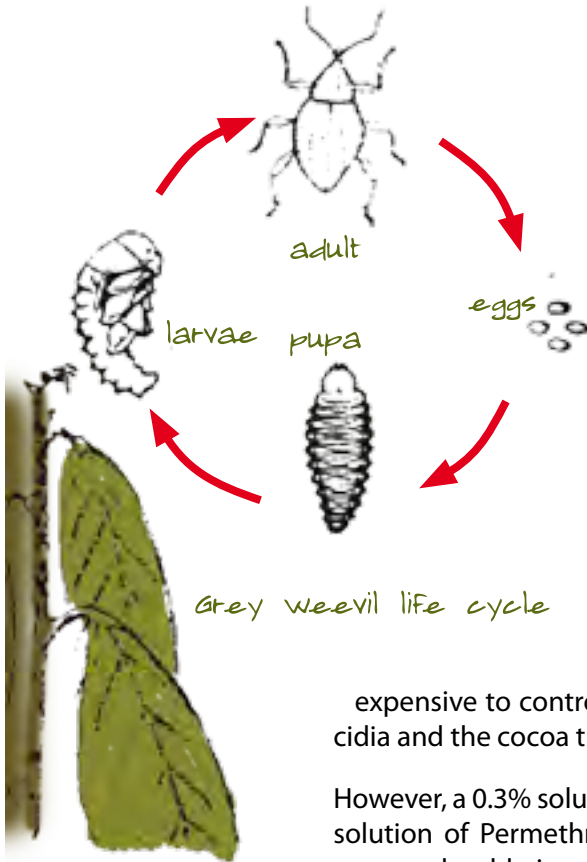

Damage

The growing shoots of cocoa and gliricidia can be so badly damaged by the grey weevil that the trees become deformed and may die. Gliricidia can be hard to establish when there is a severe attack of weevils.

Control

Keep the grass in cocoa farms cut short, or, use herbicides. Proper weed control will help protect cocoa trees from grey weevils and other pests such as longicorns, and also provide healthier growth by reducing competition for nutrients.

The weevils are very difficult and expensive to control using chemicals, as both the gliricidia and the cocoa trees must be treated.

However, a 0.3% solution of Acephate (Orthene), or 0.01% solution of Permethrin (Decis) applied with a knapsack sprayer should give good results. To make up these solutions mix together:

- 40gm "Orthene 75"
- 5ml washing up liquid
- 10 litres water

or

- 10ml "Decis"
- 5 ml washing up liquid or 2 ml surfactant
- 10 litres water

Several spray treatments may be necessary to reduce the pest to low levels.

Mealy bugs/scale insects

Description

A mealy bug is a soft white powdery insect that may attack young field seedlings or nursery seedlings.

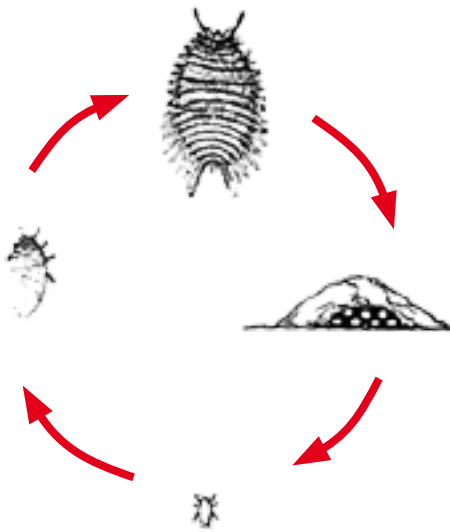

Damage

Mealy bugs can often be seen on cocoa trees in low numbers but they rarely cause economic damage and control is usually not necessary. Occasionally, however, large numbers can cause serious damage to the growing shoots of seedlings. The cocoa stems and leaves lose their colour and the growing tips may die, resulting in a poorly formed tree. This kind of damage should be controlled.

On very rare occasions, massive numbers of mealy bugs build up on gliricidia and produce black sooty mould. Growth of the gliricidia shade trees is slowed down and branches may die.

Control

You should only control mealy bugs when large numbers are found damaging the growing shoots of very young (unjorquetted) cocoa or when the growth of young gliricidia is being severely held back. Only spray those trees that are badly damaged, and not all seedlings on the farm. This is called 'spot spraying'.

The recommended chemical control is a 0.05% solution of Malathion. You should spray the trees using a knapsack until liquid 'runs off'. To make the solution, mix together

- 10ml 'Malathion 50'
- 100ml white oil
- 10 litres water

Crazy Ant Association

Mealy bugs living on cocoa and gliricidia shade trees are a major food source for crazy ants. Because crazy ants protect cocoa from a number of insects (including Pantorhytes) they should only be killed when necessary. If the mealy bugs on young cocoa are killed by spraying, the crazy ants can still survive on the mealy bugs living on the gliricidia.

LEAF FEEDERS

Caterpillars

Description

Caterpillars are the young stages of butterflies and moths. They have soft, often brightly coloured bodies, and may grow up to several centimetres in length. A number of moth caterpillars eat cocoa leaves .

Damage

Moths lay their eggs in clumps both on cocoa and shade trees. The eggs hatch after a few days and produce caterpillars. The caterpillars feed almost continuously on young cocoa leaves. They grow and change their skins about 5 times. They then pupate on the cocoa trees as seen in the diagram, on the cocoa trees or in the ground. After about 8 days the adult moths emerge.

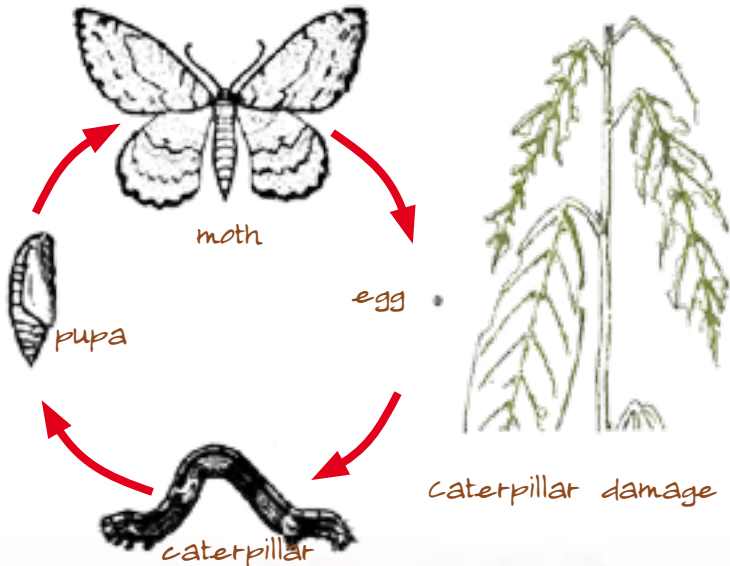

Caterpillar numbers are usually kept at low levels on cocoa by their natural insect enemies and their feeding has little effect on the trees. Occasionally, however, large numbers of caterpillars may build up and most of the young leaves may be eaten. This reduces yield on mature cocoa though the trees soon recover and produce new leaves once the pests have again been controlled by their natural enemies. This cycle usually takes a few weeks.

Control

In areas where caterpillars are often a serious problem, coconuts or gliricidia should be used as shade for cocoa because these pests are less damaging on cocoa under coconuts or gliricidia.

Chemical Control

Caterpillars that seriously damage cocoa less than 3 years old should be controlled using insecticide sprays. On trees older than 3 years, spraying becomes too expensive and difficult because of their size.

Use a knapsack to 'spot spray' trees affected by caterpillars. The best chemicals to use are a 0.1% solution of Acephate (Orthene) or a 0.2% solution of carbaryl (Septene). To make the correct solution mix together:

- 13g 'Orthene 75'
- 5ml washing up liquid
- 10 litres water

or

- 25g 'Septene 80'
- 5ml washing up liquid
- 10 litres water

Rhyparids

Description

Rhyparids are small beetles that are round in shape and about 7 mm long. They vary in colour from a shiny dark brown to green or orange. They have wings and can fly from one cocoa farm to another.



Rhyparid beetle



Rhyparid beetle

Damage

Adult Rhyparids lay their eggs on the ground. The larvae hatch out and feed on plant roots. Pupation also occurs in the ground. The life cycle takes about 6 weeks. The adults feed on young cocoa leaves.

Control

Use recommended sanitation practices such as slashing and ring weeding to control Rhyparid numbers

Chemical Control

Spray a mixture of Malathion on the leaves of badly infected plants.

- 30ml "Malathion 50
- 100ml White Oil
- 2ml Surfactant
- 10L Water

ROOT FEEDERS

Root Chafers

Description

The grubs live below the ground. They are white grubs about 1.5 cm long..

Damage

The grubs attack the cocoa seedling feeder roots. The seedling will suddenly die and roots show damage when the seedling is pulled up.

Control

Increase the fertility of the soil by adding well decomposed organic matter, including manure.

Chemical Control

Use Bifithrin as a spray on the soil around the root system of infected cocoa seedlings

POD FEEDERS

Pod Suckers

Amblypelta Damage

Description

Amblypelta adults has a light green body, light brown wings, long legs and antennae. It smells if picked up. The nymphs (young stage) are dark brown with no wings.

Amblypelta are not easy to find, except when there are severe infestations.

Damage

Significant losses to cocoa production can result from a severe *Amblypelta* attack.

Amblypelta pierce cocoa pods and feed on the sap. This leaves the pods with a dotted appearance with a number of black sunken puncture marks. Infected pods may die, or become malformed or smaller in size, reducing bean quality. Small pods can fall off the cocoa tree if attacked.

Amblypelta adults and nymphs also feed on cocoa shoots, and large numbers may damage the growing tip of young seedlings.

Amblypelta can also damage coconuts by attacking leaves and damaging the growing tip.

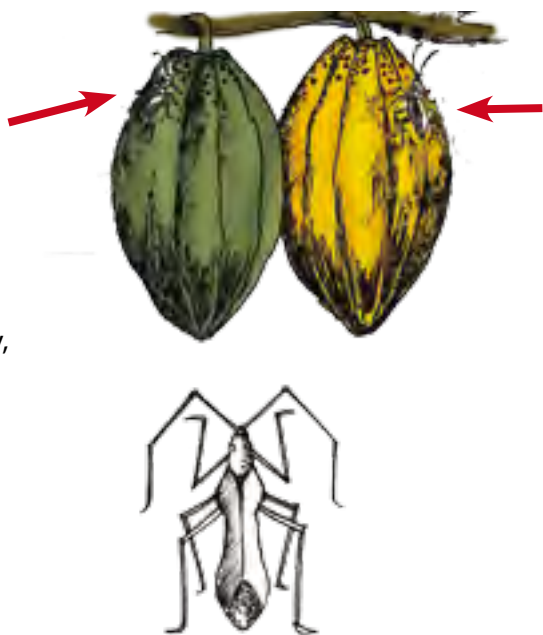

Amblypelta damage

Chemical Control

If *Amblypelta* damage is serious, chemical control should be considered.

The following mixture should be sprayed onto the trunk and main branches of affected cocoa trees using a knapsack. For this you must mix together:

- 28 ml Karate 2.5 % EC
- 10 litres water
- 2 ml surfactant

The nozzle on the mist blower must be set so that 10 litres of chemical sprays about 100 mature trees.

A second Karate treatment 14 days after the first one should be made to kill young *Amblypelta* that have recently hatched out. Only spot spray areas where *Amblypelta* are a serious problem.

Amblypelta control by large green tree ant

Biological control of *Amblypelta* using the large green tree ant (*Oecophylla*) is recommended. There is some evidence that the little fire ant (*Ochetomyrmex*) may also be effective against *Amblypelta*

Cocoa Pod Borer

Cocoa Pod Borer is a very serious cocoa insect pest. It is not in Solomon Islands yet, but it is already spreading through Bougainville. If it reaches Solomon Islands it will badly affect cocoa production. It will make it hard for smallholders to grow the crop profitably.

Description

The adult Cocoa Pod Borer is a moth the size of a mosquito. It is brown, and hard to see and lays its eggs in the grooves of cocoa pods.

When the eggs hatch out, the grub bores into the pod and feeds on the beans. When it reemerges from the pod it leaves an exit hole which can be clearly seen. It then pupates on the leaves of the cocoa tree before changing to an adult.

Damage caused by Cocoa Pod Borer

Cocoa Pod Borer attack has caused 80% -90% losses in smallholder cocoa production in other countries, therefore it is important it doesn't spread to Solomon Islands.

When the Cocoa Pod Borer grub bores into a pod it feeds on the beans inside and stops the development of the beans. Beans become discoloured and stick to the wall of the pod.



Affected pods ripen early and unevenly, and have brown discoloured beans inside which causes a dramatic reduction in cocoa production.

Control

Cultural control measures are:

- Prune cocoa trees to a manageable size to improve maintenance and access to pods for harvesting..
- Harvest regularly every pod, every tree, every week.
- Bury any pods affected by pod borer
- Improve the ventilation by following IPDM management practices

Chemical Control

It is difficult to control Cocoa Pod Borer by chemicals because the grub lives for two weeks inside the pod and is hard to reach by spraying.

Quarantine

To protect agriculture and farmer's livelihoods in Solomon's, do not carry cocoa pods from Bougainville or other infected areas into Solomon's, and tell friends and relatives about the serious risk to farmers from Cocoa Pod Borer.

Cocoa Pod Borer can also be carried on fruit, so do not carry any fruit from infected areas.

If you see cocoa pods with brown discolored beans inside, and signs of damage described, immediately inform Quarantine Officer or your local MAL Extension Officer.

Ask your MAL extension officer for more information about Cocoa Pod Borer.

DISEASES OF COCOA

COCOA DISEASES

Black pod

Description

Black Pod is caused by a fungal disease called *Phytophthora Palmivora*. Like other fungal diseases Black Pod spreads rapidly in moist, wet weather and dark, shady conditions.

The spores (small seeds) can be seen as fine white powdery substance on the pods that have turned black, easily seen on newly infected pods.

Black Pod disease is also spread by black ants, termites and other insects carrying soil up the trunk of the trees and depositing spores on uninfected pods.

Heavy rain drop splash can also transfer black pod from exposed soil onto healthy pods.

When it rains or is windy these spores are washed or blown on to other healthy pods, which go black and cause the beans inside to rot.



Black pod spread on a cocoa pod

Damage

Infected pods start out with a brown spot on the skin which spreads to cover the entire pod.

Black Pod can be very damaging, affecting most of the pods on a cocoa tree and causing big losses to cocoa production.

Ant carries infected soil to pod



Control

- Reduce shade levels and prune cocoa trees so more sunlight reaches the branches.
- Remove all black pods, place them on the ground between the cocoa rows and cover them with prunings and leaf litter.
- Control canker and chupon wilt (disease of chupons)
- Harvest regularly so pods don't get over ripe.
- Leave leaf litter on the ground to prevent raindrop splash spreading the disease.
- Remove ant tunnels from the trunks and branches of cocoa trees.
- Control black pod, especially in young productive cocoa farms so it does not take a hold.
- Plant cocoa varieties such as Amelonado, that are less susceptible to black pod.

Chemical Control

Regular spraying of pods and cherelles is necessary in high yielding cocoa farms, using the following mix:

- 30 grams Ridomil (3 match boxes)
- 10 litre of water
- 5 ml washing up liquid
- Use Copper Sandoz in the dry season so the disease does not become tolerant to Ridomil.



Hooking off black pods

Canker

Description

The same fungal disease that causes black pod also causes canker, a disease of the trunk and main branches of cocoa trees, which eventually causes the leaves of the tree to turn yellow and kills the tree slowly.



canker on tree trunk



cocoa tree slowly dies

Damage

Canker disease usually enters the trunk and branches through chupon wilt, and black pods that are left on the tree. Pantorhytes and longicorn bore holes in the bark also can act as entry points.

Control

Canker is hard to control when well established.. It is better to rehabilitate a badly infected tree by cutting it down below the canker and letting new chupons come up from the stump. Otherwise remove the tree and replant a new seedling in its place

To avoid canker infection:

- Control black pod, Pantorhytes, Longicorn and chupon wilt.
- Reduce shade and prune cocoa to allow more sunlight in.
- With a new canker, scrape the bark and expose the discoloured site.. The sun may dry it out and halt the spread.

Chemical Control

Scrape the bark and paint a fungicide mixture on the canker:

30 grams of Copper Nordox (three match boxes) in a family sized tin fish of water.

Points where canker disease can start

Through black pod stem

Blight infected chupon

Insect bore hole



scrape canker



Paint on Copper Nordox solution



Root Rot

Description

Root rot is caused by a fungal disease entering the roots of the tree and causing the roots to rot. It is common in wet, poorly drained soil.

Damage

Root rot causes all the leaves of a mature cocoa tree to suddenly turn yellow and then brown, and then the tree rapidly dies.

Root rot can spread through to the roots of nearby healthy cocoa trees if not controlled.



Control

Cocoa trees dying of root rot need to be chopped down and all the roots dug out and burnt to prevent the disease spreading.

Replacement seedlings should not be planted too close to the site of an old diseased tree. Leave a gap of at least 1.5 metres.

Don't plant cocoa in wet, poorly drained areas.



Dig out stumps and roots to stop root rot spreading. Plant new seedling 1.5 m away from old site

Thread blight

Description

Thread Blight is a fungal disease which causes small brown/ black threads, or white threads like cotton, to grow on cocoa leaves and branches.

Damage

Thread Blight causes leaves and branches to die. The dead leaves are joined together by the threads.

Damage can be severe in over shaded, unpruned cocoa trees. If many healthy leaves and branches are affected it retards tree growth and reduces production.



Thread Blight damage causes dead leaves

Pink disease

Description

Pink Disease starts as a white powder growing on the branches or trunks of cocoa trees. As the disease spreads, the old powder turns a salmon pink colour.

Damage

Pink Disease can damage young trees and spread to neighboring trees by spores blown by wind and rain.

Cocoa trunks and branches develop a rough texture and die, A patch of several dead trees on the farm can result.

Pink disease



STAGE 1
White fungus
(spider's web)



STAGE 2
Pink-white pustules



STAGE 3
Pink-orange or
pink-white crust

Control

- Reduce shade and prune cocoa trees to allow more sunlight through the canopy.
- Remove surrounding bush that may harbour the disease.
- Remove branches 50 cm below the infection site.
- Burn all removed branches.

Vascular Streak Dieback (VSD)

Description

VSD is a fungal disease which spreads by spores on young branches being blown from tree to tree in wet windy conditions.

Visible signs of VSD are rough bark on young branches, a yellow spotted leaf, white powder on young branches and a brown streak inside the stem when split open.

You will see the third or fourth leaf turn yellow with green spots and the branch will have raised bumps on the skin. The new small branches will die off.

Damage

Many young trees die off in a large patch on a newly established farm.

VSD is not currently in Solomon Islands, but was very common in East New Britain, PNG, until the introduction of resistant cocoa varieties.

If VSD gets into Solomon Islands it will be devastating because Amelonado cocoa is not resistant to the disease.



VSD in young tree

Brown streak inside stem

Control

Quarantine

Cocoa trees which are dying, with green spots on yellow coloured leaves may have VSD. To confirm the tree has the disease, see if the inside of a split branch is stained with brown streaks.

Immediately report such a tree to your Quarantine or MAL Extension Officer.

MEANING OF WORDS USED

Acidic	Soils which have a PH of less than 7.0. Such soils do not contain any lime, and are usually found inland, especially on mountains.
Anoplolepis	See crazy ant.
Amblypelta	An insect which eats and marks cocoa pods with spot, damaging pods.
Amelonado	Type of cocoa grown in Solomon Islands. Good variety for farmers to manage.
Bean	The seed from which cocoa is made.
Biological control	The control of a pest, disease or weed without using chemicals, by breeding a parasite or predator which attacks the pest, disease or weed.
Bifithrin	A chemical used for control of root chafers.
Blight	A fungal disease same as black pod sickness which kills young nursery seedlings.
Budding/ Budgrafting	A way of grafting when a bud is taken from one plant and joined onto another to get a good plant like the mother tree.
Budgrafting juvenile	A type of grafting where very young rot stock (seedlings only a few weeks old) are used to budgraft on to.
Bud wood	A young branch cut off mother tree to provide buds for budgrafting. Leaves removed called budstick.
Canker	A disease, same as black pod found on trunks and branches
Canopy	The top part of a tree, consisting of the branches and leaves.
Caterpillar	Also called larva. The young growth stage of a butterfly or moth.
Chemical	A poisonous substance used to control pests and diseases
Cherelle	The immature pod of a cocoa tree.
Chupon	A vertical shoot which grows from a cocoa trunk or branch, also known as stilman or water shoot.
Chupon wilt	A disease like seedling blight which kills chupon leaves and branches.

C.L.I.P.	Cocoa Livelihoods Improvement Project. The Australian Government Aid Program project supporting the cocoa industry in Solomon Islands.
Clump	A term used when wet beans stick together during fermentation.
Compression/compress	Making the soil hard by walking on it, or (of soil) by the action of rain drops on a bare soil surface, or by machinery such as tractors.
Contaminate	Having some undesirable substance on or in a sample or food, e.g. cocoa beans are easily contaminated by smoke.
Copper Sandos	A chemical for controlling black pod and canker
Cotyledons	The sections found inside a cocoa seed
Cover crop	A creeping plant used to cover the soil surface to smother weeds, prevent erosion, regulate soil temperature and provide nitrogen.
Crazy Ant	(Anoplolepis). A small brown ant (1cm long) which nests on the ground in leaf litter and climbs cocoa trees providing biological control from Pantorhytes, and pod suckers. It runs fast everywhere.
Criss Crossing	Branches which cross each other and need pruning.
Crows feet	Many small branches at the end of interlocking branches (needing pruning to only one.)
Crop Calendar	A term used to plan the give best time of year to do different tasks on the cocoa farm
Cushion	See flower cushion
Decis	Type of chemical used for insect control.
Deficiency	A shortage of a nutrient which is essential for healthy growth.
Dimethoate	Chemical used in Panseptia control
Direct Planting	Cocoa seed planted direct into the ground without using a nursery.
Droopy branches	Cocoa branches hanging below jorquette, need pruning.
E.C.	Emulsifiable Compound (concentration or strength of chemical, diluted with water)

Fan branch	A main branch of a cocoa tree, which grows laterally, pods produced mainly on fan branches
Feeder roots	Fine roots in the topsoil which absorb the nutrients needed for plant growth.
Fermentation	The process whereby mucilage is broken down by bacteria (micro organisms) which feed upon the sugars.
Fertilizer .	A type of substance with nutrients to enrich the soil
Flower cushion	A place on the trunk or branch of a cocoa tree at which there is a cluster of flower buds which can develop into flowers at any time during the life of the tree.
Flue pipe	A cocoa dryer chimney.
Flush (of leaves)	A period of rapid growth and production of new leaves.
Flush (of pods)	Peak production period.
Frass	The waste products of woodboring insects
Fungicides	Chemicals used to prevent or cure diseases.
Furrow	A groove on the outside of a cocoa pod.
Germination	The time when the first root or shoot emerges from a seed.
Giant cocoa termite	Type of termite or white ant, which damages cocoa trees.
Gliricidia	A type of leguminous tree used for cocoa shade.
Grey weevil	An insect which damages young cocoa trees branches and leaves.
Hardening off	Exposing cocoa seedlings to more sunlight to strengthen them before planting out.
Height pruning	Pruning cocoa trees down to a manageable size.
Herbicides	Chemicals used to kill weeds.
Husk	The outer layer of a cocoa pod.
Insecticide	A chemical used to control insects.
Infilling	Planting cocoa seedlings to replace seedlings that have died.
Interlocking	Branches from neighbouring trees that are needing tip pruning.

Interplanting	Growing two or more types of plant on the same piece of land
I.P.D.M.	Integrated Pest and Disease Management. A system of managing cocoa which uses best practices.
Jorquette	The point at which fan branches develop from the terminal bud of a cocoa tree. The tree ramifies and forms a jorquette.
Karate	A chemical used for insect control in cocoa.
Larva	The immature stage of an insect, usually a maggot or caterpillar.
Legumes	Plants which increase nitrogen to the soil. They contain bacteria in their roots which add nitrogen.
Light penetration	The amount of sunlight that reaches cocoa tree leaves needed for good pod production.
Litter	Dead and decomposing leaves and twigs on the surface of the soil in a cocoa farm.
Longicorn	Insect whose grub bores under the bark of cocoa tree.
M.A.L.	Ministry of Agriculture and Livestock.
Malathion	Chemical used for controlling leaf eating insects.
Mealy Bug	Insect that attacks cocoa seedling growing tips, leaves and branches
Metalaxyl	Chemical used in controlling fungal disease. (same as Ridomil)
Micro-organisms	Extremely small living things, such as bacteria, fungi and yeasts. In the soil, many different kinds of microorganisms work together to break down dead leaves and stems, to produce organic matter and essential nutrients.
Mucilage	A slippery substance rich in sugars, which surround the beans in a cocoa pod. Also called pulp.
Mulching	Covering the soil with dead leaves or husks.
Nitrogen	One of the 17 nutrients necessary for plant growth. Nitrogen is needed in relatively small amounts by cocoa.
NPK	Fertilizer which contains three nutrients, Nitrogen (N) Phosphorous (P) and Potassium (K) Used to improve growth and production.

Nutrients	Chemicals which are needed by plants and animals for healthy growth.
Ochetmyrmax	Small fire ant living on cocoa trees which causes skin irritation to people working with cocoa
Oecophylla	Green tree ant, sometimes called Yellow Giant tree ant, "Ekofla"
Organic matter	Decayed parts of plants or animals.
Orthene	Chemical used to control leaf eating insects.
Pansepta	Insect whose grubs bore into smaller cocoa branches.
Pantorhytes	Weevil whose grubs bore into cocoa trees
Peduncle	Part of a cocoa pod, arising near stem.
pH	Measure the acidity or alkalinity of the soil. A reading of 7 is neutral. Below 7 is acid, above 7 is alkaline.
Phosphorus	One of the 17 elements which are needed for plant growth. Phosphorus is important for healthy roots. Cocoa responds well to fertilizers containing phosphorus.
Pigeon pea	Temporary shade for cocoa, A legume that provides nitrogen, improves the soil, and produces food for humans and livestock.
Placenta	The central core of a cocoa pod, to which the seeds are attached.
Pod	The fruit of a cocoa tree.
Pod feeder / sucker	Insect which feeds on the cocoa pod.
Polythene planting bag	A black plastic bag used for growing cocoa seeds in a nursery.
Potassium	One of the 17 nutrients necessary for plant growth. Potassium is needed in moderate amounts by cocoa for pod growth.
Processing	Fermenting and drying cocoa beans
Pruning	Removal of branches of a tree to regulate pod production, make harvesting easier, and reduce the incidence of pests and diseases.
Pulp	See mucilage.
Pupation	The life cycle stage that comes before the adult stage in insects.
Pustules	Raised bark found in Pinks disease

Quarantine	Control measures taken to stop the importation of damaging pests and diseases from other countries.
Radical pruning	Height pruning of a big cocoa tree to bring to down to a manageable size.
Rammification, ramify	Terminal bud or growing tip splitting into 4-6 Fan branches, forming a jorquette.
Rehabilitation	Management of an old cocoa farm to bring it back into production.
Rhyparid	Beetle which eats cocoa leaves.
Ridomil	Chemical used to control fungal diseases including black pod. (See Metalaxl)
Ring weeding	Removing all weeds within a limited radius of the trunk of a tree.
Rogor 30	Chemical used for Pansepta control.
Sap	Blood of a tree
Secondary branches	Branches which grow from the main fan branches.
Seedling blight	A fungal disease affecting young cocoa trees.
Shell	The outside skin layer of a cocoa bean.
Slashing	Cutting down high grass on a cocoa farm.
Soil erosion	The removal of soil by rain splash or water flow. It is especially serious on bare soil and steep slopes in areas where there is heavy rainfall.
Spindly	Seedling growing too tall and thin due to a shortage of light.
Spores	The seed of fungus diseases.. Spores are so small that they cannot be seen without a microscope, and they are easily carried about by wind.
Stem feeder	Insect which feeds on cocoa tree stems.
Stone cell layer	The hard layer of the pod inside the husk.
Storey	A layer of the cocoa canopy
Stunted	Very poor limited growth.

Subsoil	The lower layers of soil, with usually little organic matter, and less fertile than the topsoil.
Surfactant	A chemical like washing-up soap which helps other chemicals to stick to cocoa leaves.
Taint	A bad flavour in the cocoa. A type of contamination.
Tap root	The main downward growing root of a plant.
Terminal bud	The top end of a seedling or branch which is the growing tip.
Topography	Shape of the land.
Topsoil	The uppermost layer of soil, usually rich in organic matter.
Turning	Moving the wet and dry cocoa so middle goes to edges and top to bottom to get even fermenting and dryness.
Trace elements	Nutrients which are essential to plants, but required in very small amounts.
VSD	Vascular Streak Dieback. A bad fungal disease found in East New Britain, PNG.
Waterlogging	Too much water in and on the top of the soil which stops air from reaching the roots, thereby preventing them from obtaining nutrients.
Water shoot	See chupon
White oil	A chemical mixed with Malathion to help it stick to cocoa leaves.
Windbreak	A barrier against the wind to protect a crop. A windbreak can consist of a fence or trees.
Yield	Amount of cocoa produced from a tree, or an area, e.g. tonnes per hectare.

HANDY CONVERSION TABLES

<p>Wet Bean to Dry Bean</p>	<p>100 kg wet bean at about 40 % recovery = 40 kg dry bean</p>	<p>1 cubic metre wet bean = 1 tonne,= 1000 kg wet bean 1000 cubic cm = 1 kg wet bean</p>
<p>1 bag dry cocoa 16 bags per tonne</p>	<p>62.5 kg dry cocoa per bag, + 1 kg sack=63.5kg</p>	<p>178-138 kg wet bean = 1 bag dry bean</p>
<p>Length</p> <p>1 centimetre (cm)=0.394 inches 1 cm= 10 millimetre 100 cm = 1 metre 1000 metre = 1 kilometre 1 kilometre =0 .62 miles</p>	<p>Imperial to metric</p> <p>1 inch = 2.54 cm 12 inches = 1 foot =30.5 cm 1 yard = 3 ft = 91.4 cm 1 mile = 1.6 kilometre</p>	<p>Area</p> <p>1 hectare = 2.47 acres 1 hectare = 10000 square metres 1 sq metre = 10,000 sq cm</p>
<p>Volume</p> <p>1 litre = .22 gallons 1 litre = 1000 millilitres</p>	<p>1 gallon = 4.55 litres 1 fluid ounce =28.35 ml</p>	
<p>Temperature</p> <p>Centigrade to Farenheit 9/5 Centigrade plus 32</p>	<p>Farenheit to Centigrade 5/9 Farenheit minus 32</p>	
<p>Weight</p> <p>1 kilogram = 2.2 pounds 1 tonne = 1000 kg 1 kg = 1000 gram</p>	<p>1 pound = 0.454 kg 1 pound = 16 ounces (oz) 1 ton=1016 kg</p>	

RECORD OF PLANTINGS

Farm 1

Number of cocoa trees planted _____ Year planted _____

Farm 2

Number of cocoa trees planted _____ Year planted _____

Farm 3

Number of cocoa trees planted _____ Year planted _____

